



ELESTA

Elesta Elektrotechnik AG	industry relays and accessories	edition 2003
--------------------------	---------------------------------	--------------



table of contents

SKR-industry relay	4
SKR-screw socket with accessories	14
SFR-industry relay	16
SFR-screw socket with accessories	27
LR-power relay	28
FR-miniature relay	34
PR-PCB relay	42
MR-special relay	48

technical data has been fully checked, but accuracy of printed matter not guaranteed

product range

SKR line



- industry relay
- standard 10 A
- plug-in relay 2-pole
- plug-in relay 3-pole



- PCB version
- double contact

SFR line

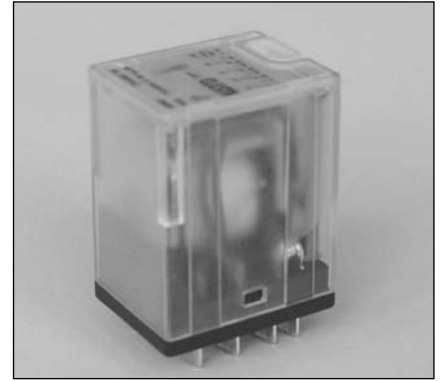

- industry relay
- standard 5 A
- plug-in relay 4-pole

FR line

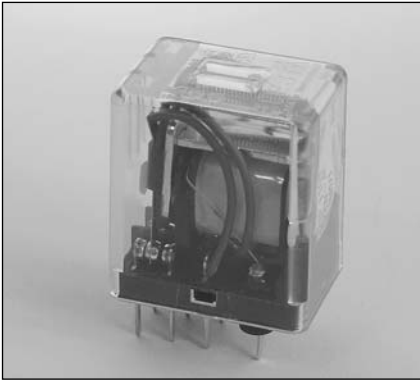

- miniature relay 4 A
- PCB version

FR line socket

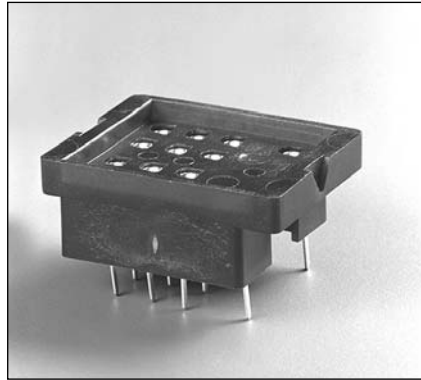

- matching FR line

LR line

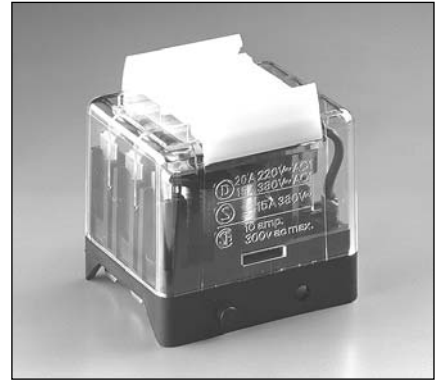

- power relay

PR line

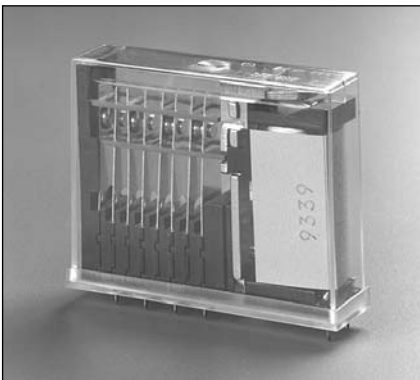

- PCB relay 6 A
- forcibly actuated

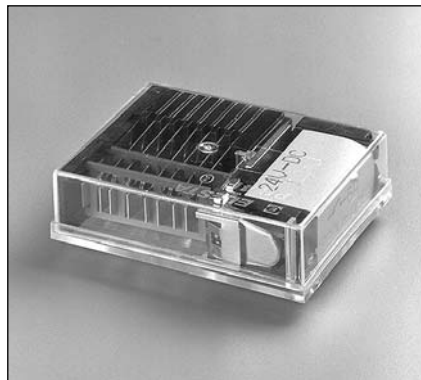

MR line



- universal relay
- soldering version
- plug-in version 8-pole
- plug-in version 11-pole
- high impedance, sensitive coil



SKR - industry relay

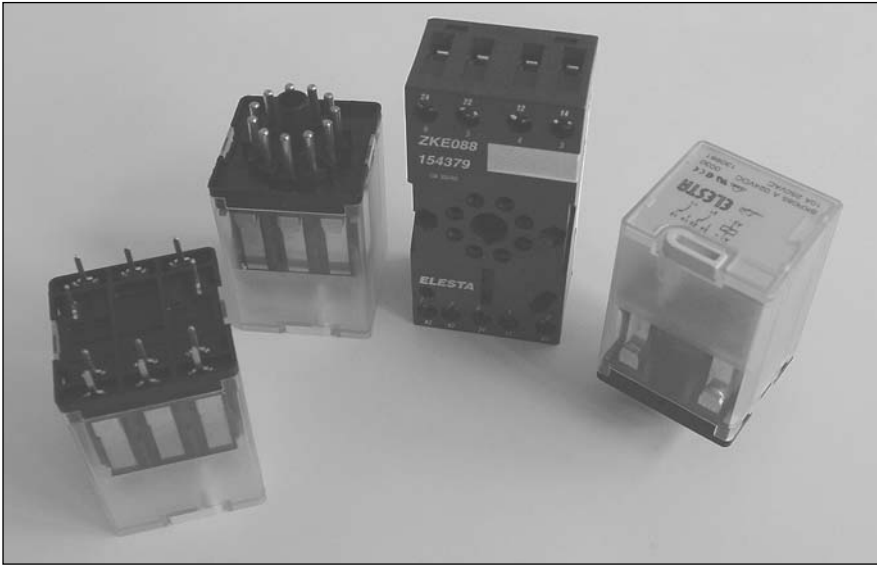

the universal relay SKR

The strengths of the SKR industry relay lie in the mature and thought-out construction.

Over-average contact safety and life time, electrical and mechanical status indication as well as the unsurpassed construction from only six assemblies makes the relay to the excellent power switch.

the time module STM

8 adjustable functions and 8 selectable time ranges: these are the special features of the time module STM. With only one version of the module all essential features as operating voltage, functions and time ranges are adjustable.

The result: a simple and cost-effective warehousing.

the socket

Simple to handle screw-terminal and clear, rich in contrast labeled clamp identification, are the base for a problemless use.

The ZKE/ZKX sockets permit a rapid and secure installation.

The separated inputs and outputs are located at one level. There is also the possibility to plug a time module STM or other additional modules together with the SKR relay.

features

- simple construction
- high contact load
- contact spring in Beryllium bronze
- safe wire diameter
- long life time
- large coil room
- electrical or mechanical status indication
- integrated manual actuation
- simple installation
- indelible scheme on socket or cover following international standards

applications

- mostly used where a time-dependent event must be headed
- switch panel making
- machine industry
- illuminations
- locking of functions
- gate control
- machine control

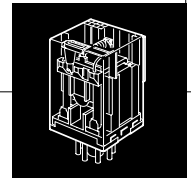

type number key

SKR 115 A ... 024VDC

coil voltage

VDC = direct current
VAC = alternating current

standard voltage

VAC: 024, 115, 230 V
VDC: 024, 110

options

D = double contact (AgCuNi)
L = electrical position indication
F = free wheel diode
FL = free wheel diode and electrical position indication
B = without manual actuation
T = push-button actuation
C = current coil

relay version

SKR 085 A
SKR 115 A
SKR 122 A

A = mechanical position indication
standard: manual actuation

order samples

manual actuation	position indication	free wheel diode	LED display						
•	•			SKR085 A	VDC/AC	SKR115 A	VDC/AC	SKR122 A	VDC/AC
•	•	•		SKR085 AF	VDC	SKR115 AF	VDC	SKR122 AF	VDC
•	•		•	SKR085 AL	VDC/AC	SKR115 AL	VDC/AC	SKR122 AL	VDC/AC
•	•	•	•	SKR085 AFL	VDC	SKR115 AFL	VDC	SKR122 AFL	VDC



SKR085 - industry relay, 8-pole



Industry relay with two change-over contacts in different versions.

order numbers

serial version	SKR 085 A ...
	VDC/AC
with mechanical position indication	

contact specifications

contact material	AgCuNi
contact type	single contact
nominal switching capacity	250 VAC 10 A AC1 2500 VA 440 VAC 4 A AC1
electric life expectancy	app. 700'000 operations 250 VAC, 10 A, AC1 (360 operations/h)
inrush current max.	40 A for 200 ms
switching current range	50 mA to 10 A
switching power range	0,3 VA(W) to 2500 VA

options

electrical	
position indication	SKR 085 L ..
with free wheel diode	SKR 085 F ..
electrical	
position indication	
with free wheel diode	SKR 085 FL ..
double contact	SKR 085 D ..
without manual	
actuation	SKR 085 B ..
push-button actuation	SKR 085 T ..
current coil	SKR 085 C ..

(combinations with mechanical and electrical position indication and free-wheel diode are possible)

general data

mechanic life expectancy	> 10 ⁸ operations
mechanical switching frequency	20 Hz
pull-in time	12 ms at DC / 3-10 ms at AC
release time	3,5 ms at DC / 2-15 ms at AC
bounce time normally open contact	3,5 ms at DC / 3-6 ms at AC
bounce time break contact	9 ms at DC / 6-11 ms at AC
shock resistance	AK: > 10 g
vibration resistance	10-55 Hz, AK: 10 g, RK: 3 g
test voltage, coil/contact	2500 V _{eff}
test voltage, open contact	1500 V _{eff}
insulation resistance	10 ¹² Ohm
weight	app. 80 g
installation situation	any
ambient temperature	max. +70 °C
protection standard	IP 40

accessories

plug-in socket	ZVE 8
	ZKE 088
metal clamp	ZKR 008

tests, instructions

certificates	UL, CSA, VDE
insulation group	VDE 0110 / group C 250 VAC

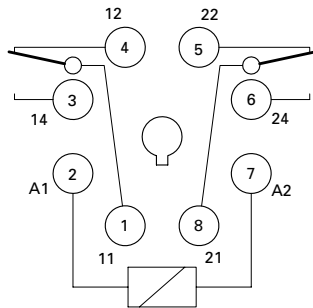
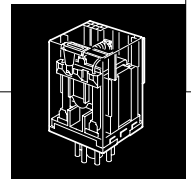

circuit diagram

dimensions

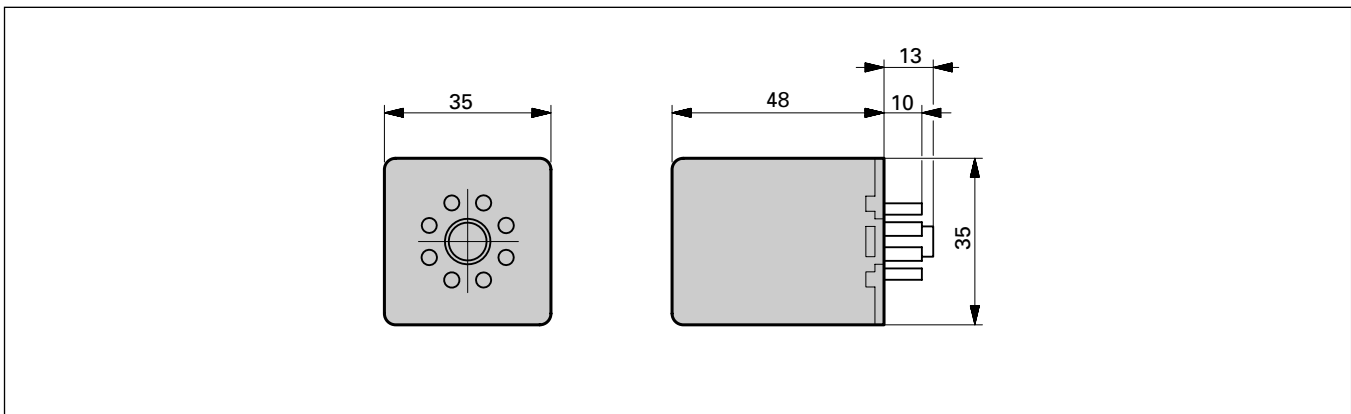

coil specifications

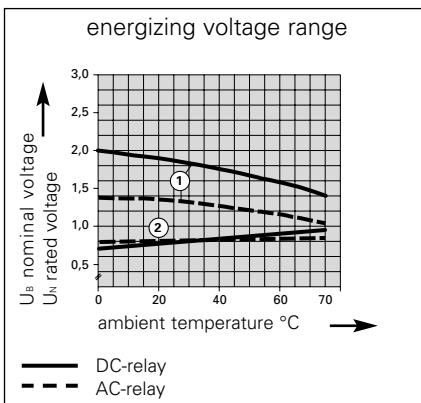

standard coils for direct current (other voltages on enquiry)

rated voltage VDC	pull-in voltage at 20 °C	reset voltage at 20 °C	nominal current mA	resistance Ohm at 20 °C	tolerance %
12	9,6	≥ 0,6	104	115	+/-10
24	19,2	≥ 1,2	50,0	480	+/-10
48	38,4	≥ 2,4	25,9	1850	+/-10
110	88,0	≥ 5,5	12,2	9'000	+/-15
220	176,0	≥ 11	7,58	29'000	+/-15

standard coils for alternated current (other voltages on enquiry)

VAC	pull-in voltage at 20 °C	reset voltage at 20 °C	nominal current mA	resistance Ohm at 20 °C	tolerance %
12	9,6	≥ 0,6	211	13,3	+/-10
24	19,2	≥ 1,2	104	52	+/-10
48	38,4	≥ 2,4	55	240	+/-10
110	88,0	≥ 5,5	23	1'120	+/-10
220	176	≥ 11,0	12,0	4'450	+/-10
230	184	≥ 11,5	11,5	5'600	+/-10

- single relay, no heat concentration by surrounding components with self-heating.
 - on time 100%
- 1) max. energizing voltage without contact load
 - 2) min. energizing voltage (guaranteed value), without operation in advance.

SKR115 - industry relay, 11-pole



Industry relay with three change-over contacts in different versions

order numbers

serial version SKR 115 A ...
VDC/AC
with mechanical position indication

contact specifications

contact material	AgCuNi
contact type	single contact
nominal switching capacity	250 VAC 10 A AC1 2500 VA 440 VAC 4 A AC1
electric life expectancy	app. 700'000 operations 250 VAC, 10 A, AC1 (360 operations/h)
max. inrush current	40 A for 200 ms
switching current range	50 mA to 10 A
switching power range	0,3 VA to 2500 VA

options

electrical position indication SKR 115 L ..
with free wheel diode SKR 115 F ..
electrical position indication with free wheel diode SKR 115 FL ..
double contact SKR 115 D ..
without manual actuation SKR 115 B ..
push-button actuation SKR 115 T ..
current coil SKR 115 C ..

(combinations with mechanical and electrical position indication and free-wheel diode are possible)

general data

mechanic life expectancy	> 10 ⁸ operations
mechanical switching frequency	20 Hz
pull-in time	12 ms at DC / 3-10 ms at AC
release time	3,5 ms at DC / 2-15 ms at AC
bounce time normally open contact	3,5 ms at DC / 3-6 ms at AC
bounce time break contact	9 ms at DC / 6-11 ms at AC
shock resistance	AK: > 10 g
vibration resistance	10-55 Hz, AK: 10 g, RK: 3 g
test voltage, coil/contact	2500 V _{eff}
test voltage, open contact	1500 V _{eff}
insulation resistance	10 ¹² Ohm
weight	app. 80 g
installation situation	any
ambient temperature	max. +70 °C
protection standard	IP 40

accessories

plug-in socket ZVE 11
ZKE 118
ZKX 118
time module STM 100
metal clamp ZKR 008

tests, instructions

certificates UL, CSA, VDE
insulation group VDE 0110 / group C 250 VAC

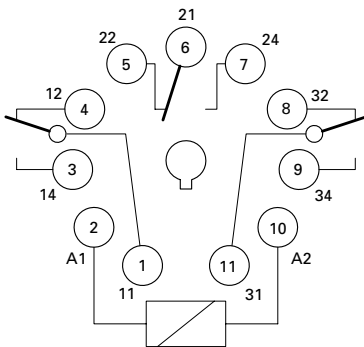
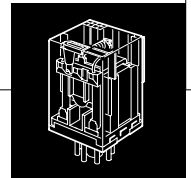

circuit diagram

dimensions

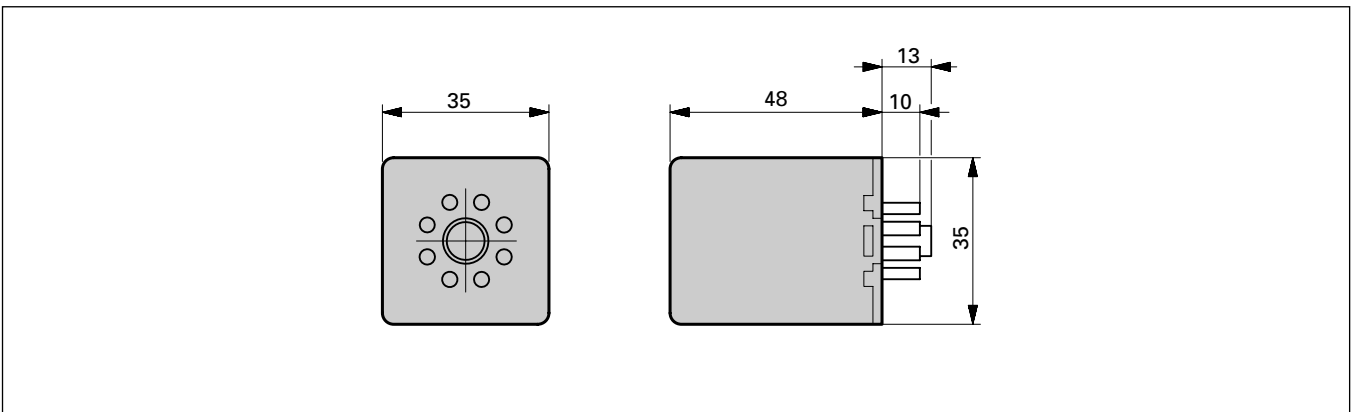

coil specifications

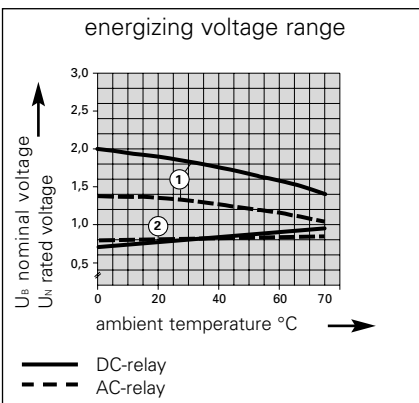

standard coils for direct current (other voltages on enquiry)

rated voltage VDC	pull-in voltage at 20 °C	reset voltage at 20 °C	nominal current mA	resistance Ohm at 20 °C	tolerance %
12	9,6	≥ 0,6	104	115	+/-10
24	19,2	≥ 1,2	50,0	480	+/-10
48	38,4	≥ 2,4	25,9	1850	+/-10
110	88,0	≥ 5,5	12,2	9'000	+/-15
220	176,0	≥ 11	7,58	29'000	+/-15

standard coils for alternated current (other voltages on enquiry)

VAC	pull-in voltage at 20 °C	reset voltage at 20 °C	nominal current mA	resistance Ohm at 20 °C	tolerance %
12	9,6	≥ 0,6	211	13,3	+/-10
24	19,2	≥ 1,2	104	52	+/-10
48	38,4	≥ 2,4	55	240	+/-10
110	88,0	≥ 5,5	23	1'120	+/-10
220	176	≥ 11,0	12,0	4'450	+/-10
230	184	≥ 11,5	11,5	5'600	+/-10

- single relay, no heat concentration by surrounding components with self-heating.
 - on time 100%
- 1) max. energizing voltage without contact load
 - 2) min. energizing voltage (guaranteed value), without operation in advance.



SKR122 - industry relay, PCB version



Industry relay with three change-over contacts in different versions

order numbers

serial version	SKR 122 A ...
	VDC/AC
with mechanical position indication	

contact specifications

contact material	AgCuNi
contact type	single contact
nominal switching capacity	250 VAC 10 A AC1 2500 VA 440 VAC 4 A AC1
electric life expectancy	app. 700'000 operations 250 VAC, 10 A, AC1 (360 operations/h)
max. inrush current	40 A for 200 ms
switching current range	50 mA to 10 A
switching power range	0,3 VA to 2500 VA

options

electrical	
position indication	SKR 122 L ..
with free wheel diode	SKR 122 F ..
electrical	
position indication	
with free wheel diode	SKR 22 FL ..
double contact	SKR 122 D ..
without manual	
actuation	SKR 122 B ..
push-button actuation	SKR 122 T ..
current coil	SKR 122 C ..

(combinations with mechanical and electrical position indication and free-wheel diode are possible)

general data

mechanic life expectancy	> 10 ⁸ operations
mechanical switching frequency	20 Hz
pull-in time	12 ms at DC / 3-10 ms at AC
release time	3,5 ms at DC / 2-15 ms at AC
bounce time normally open contact	3,5 ms at DC / 3-6 ms at AC
bounce time break contact	9 ms at DC / 6-11 ms at AC
shock resistance	AK: > 10 g
vibration resistance	10-55 Hz, AK: 10 g, RK: 3 g
test voltage, coil/contact	2500 V _{eff}
test voltage, open contact	1500 V _{eff}
insulation resistance	10 ¹² Ohm
weight	app. 80 g
installation situation	any
ambient temperature	max. +70 °C

accessories

PCB socket	ZKR 003
metal clamp	ZKR 008

tests, instructions

certificates	UL, CSA, VDE
insulation group	VDE 0110 / group C 250 VAC

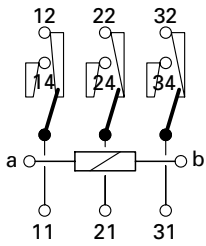
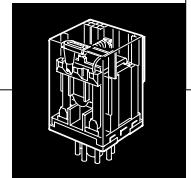

circuit diagram

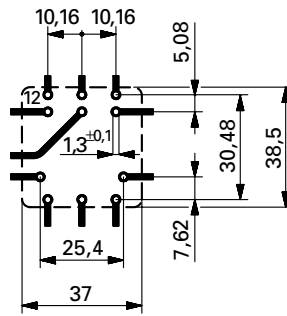

drilling plan (view on solder side)

dimensions

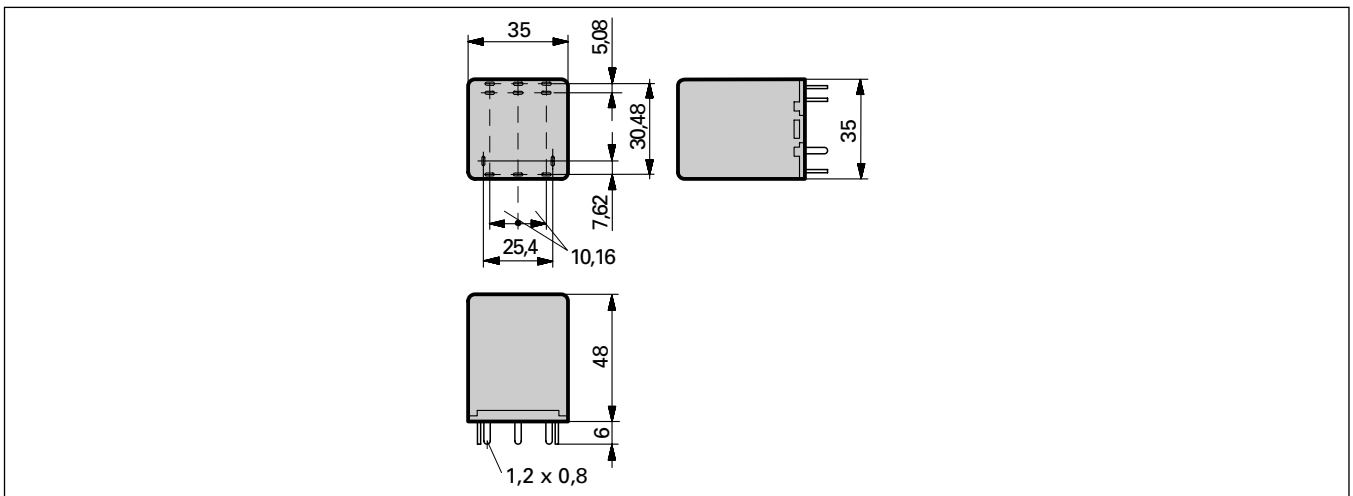

coil specifications

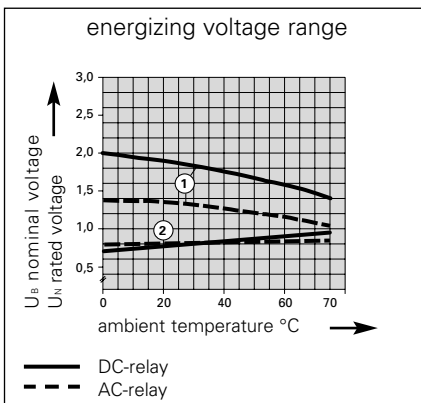

standard coils for direct current (other voltages on enquiry)

rated voltage VDC	pull-in voltage at 20 °C	reset voltage at 20 °C	nominal current mA	resistance Ohm at 20 °C	tolerance %
12	9,6	≥ 0,6	104	115	+/-10
24	19,2	≥ 1,2	50,0	480	+/-10
48	38,4	≥ 2,4	25,9	1850	+/-10
110	88,0	≥ 5,5	12,2	9'000	+/-15
220	176,0	≥ 11	7,58	29'000	+/-15

standard coils for alternated current (other voltages on enquiry)

VAC					
12	9,6	≥ 0,6	211	13,3	+/-10
24	19,2	≥ 1,2	104	52	+/-10
48	38,4	≥ 2,4	55	240	+/-10
110	88,0	≥ 5,5	23	1'120	+/-10
220	176	≥ 11,0	12,0	4'450	+/-10
230	184	≥ 11,5	11,5	5'600	+/-10

- single relay, no heat concentration by surrounding components with self-heating.
 - on time 100%
- 1) max. energizing voltage without contact load
 - 2) min. energizing voltage (guaranteed value), without operation in advance.



SKR-contact specifications

AgCuNi single contact

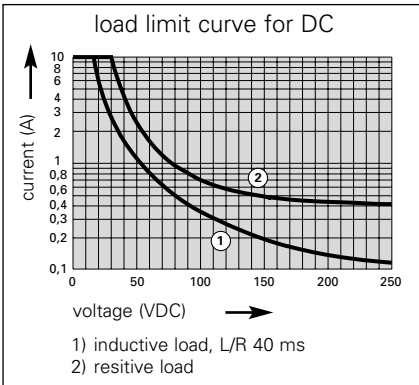

data valid for relay

contact material
contact type
nominal switching capacity
electric life expectancy
max. inrush current
switching current range
switching power range
contact resistance

SKR 085 SKR 115 SKR 122
AgCuNi (Ag1,88 Ni0,12)
single contact
250 VAC 10 A AC1 2500 VA 440 VAC 4 A AC1 1600 VA
app. 700'000 operations 250 VAC 10 A AC1 (360 operations/h)
40 A for 20 ms
30 mA to 10 A
0,18 VA to 2500 VA
20 mΩ

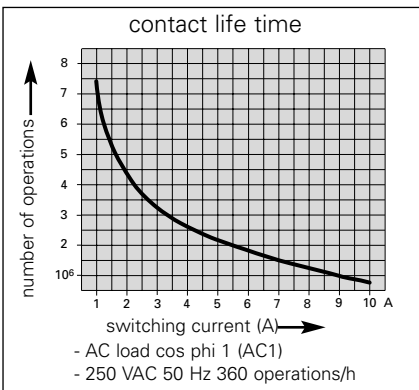

AgCuNi double contact

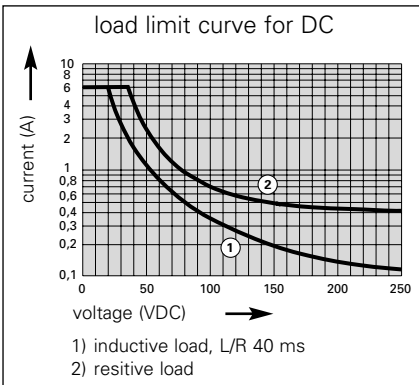

data valid for relay

contact material
contact type
nominal switching capacity
electric life expectancy
max. inrush current
switching current range
switching power range
contact resistance

SKR 085D SKR 115D SKR 122D
AgCuNi (Ag1,88 Ni0,12)
double contact
250 VAC 6 A AC1 1500 VA
app. 150'000 operations 250 VAC 6 A AC1 (360 operations/h)
15 A für 20 ms
10 mA to 6 A
0,06 VA to 1500 VA
10 mΩ

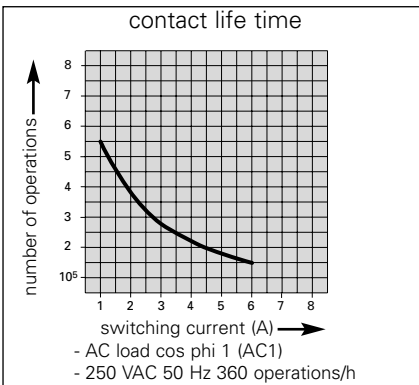

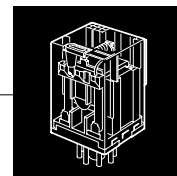

ZKR 003 matching to SKR 122

order numbers

ZKR 003

general data

nominal data	max. 10 A 400 V
test voltage	2000 V _{eff}
contact spring material	Ms improved
fixing	soldering pin 1 x M3
creeping resistance	CTI 250
weight	app. 7 g
installation situation	any
ambient temperature	-40 to +85 °C
number of poles	11-pole
protection standard	IP 30

accessories

metal clamp
ZKR 008

tests, instructions

certificates	UL, CSA
insulation group	VDE 0110 / group C 250 VAC

dimensions

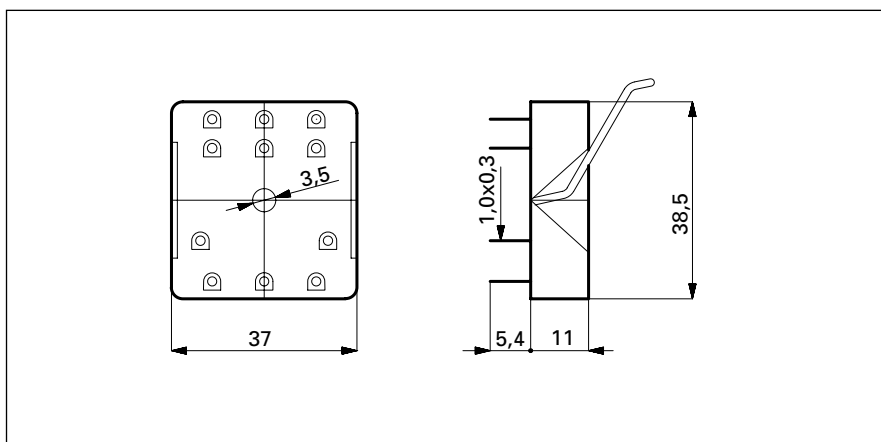

drilling plan

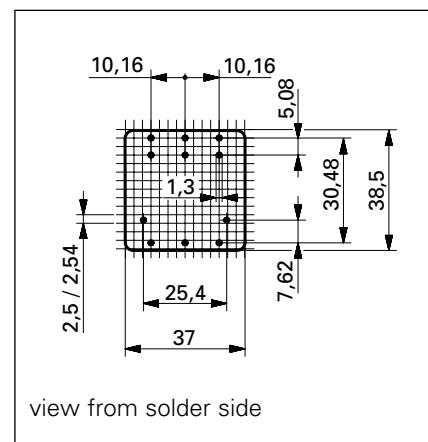

SKR-screw socket with accessories

socket

ZVE8



ZKE088

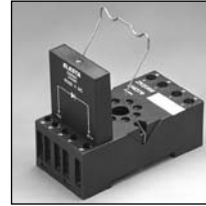

data

nominal data		400 VAC 10 A	400 VAC 10 A
dimensions (L x B x H)	[mm]	57 x 38 x 28,5	75 x 38 x 26
ambient temperature	[°C]	-40 to +85	-40 to +85

accessories

plug-in modules			E...
time module			STM 100
metal clamp		ZKR008	ZKR008

ZVE11



ZKX118

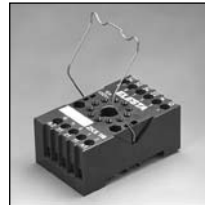

ZKE118

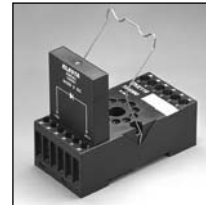

data

nominal data		400 VAC 10 A	400 VAC 10 A	400 VAC 10 A
dimensions (L x B x H)	[mm]	57 x 38 x 28,5	62 x 38 x 26	75 x 38 x 26
ambient temperature	[°C]	-40 to +85	-40 to +85	-40 to +85

accessories

plug-in modules				E...
time modules				STM 100
metal clamp		ZKR008	ZKR008	ZKR008

tests, instructions

certificates		UL, CSA
insulation group		VDE 0110 / group C 250 VAC

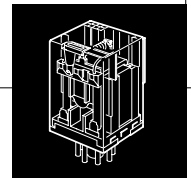

time modules

STM 100



data

compatible to socket	ZKE088/118
function	programmable
time range	0,05s - 240h
rated voltage	24 - 240 VDC/VAC

general data

time range	8 ranges: 1s, 10s, 1m, 10m, 1h, 10h, 1d, 10d
time adjustment	variable, 5% - 100% of the time range
time function	8 functions, selectable by DIP switches
display	green LED for ON-status, blinking at time delay
dimensions	B x H x T = 35 x 46,7 x 10,3 mm (without clamp)
weight	app. 14 g
permissible ambient temperature	-25 to +55 °C
nominal voltage	24V to 240V AC (-15%...+10%) , 24V to 250V DC (-15%...+10%)
frequency	48 Hz to 63 Hz
max. power consumption	24V AC/DC: 70mW , 240V AC/DC: 700mW
min. impulse time (B1)	AC: 50ms, DC: 30 ms
min. pause time (B1)	AC&DC: 100ms at 25°C, AC&DC: 140ms at 55°C
pull-in delay	AC: max. 40ms, DC: 20ms
reset time delay	AC&DC: max. 100ms at 25°C, AC&DC: max. 140ms at 55°C
control voltage	24V: min. 80% of supply voltage 230V: min. 95% of supply voltage
time delay after power loss	max. 10ms
start-up time	60ms
re-readiness time	max. 100ms at 25°C, max. 150ms at 55°C
reset at	UN ≤ 10V _{eff}
precision at the scale stops	±0,5%
repeatability	<0,5% or 5ms (in % from scale value)
accuracy in adjustment	≤5%
temperature influence	≤0,01% / °C
voltage influence	≤0,001% / V
max. load current	100mA at 25°C

plug-in modules

E...

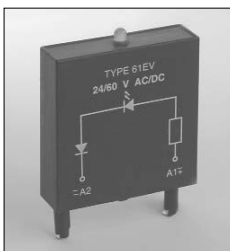

data

compatible to socket	ZKE088/118	
free wheel diode	6 - 220 VDC	E 21
RC-circuit	110 - 230 VAC	E 51C
varistor	6 - 24 VAC	E 71
varistor	6 - 230 VAC	E 81
LED	24 - 60 VDC/ VAC	E 61EV
LED	110 - 230 VDC/ VAC	E 91V



SFR - industry relay

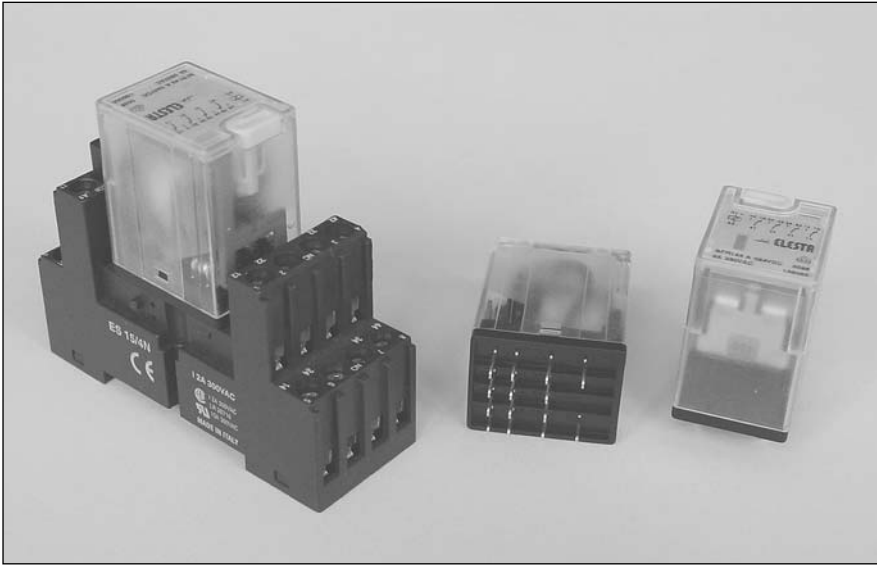

the SFR-industry relay

SFR industry relays are the ideal relays for control systems.

A simple construction guarantees the safety of these relays. The large contact rivet (\varnothing 3 mm) guarantees the extraordinary life time.

An ideal product for control systems in combination with the socket program and the accessories.

features

- large contacts (\varnothing 3 mm)
- extraordinary life time
- mechanical lever integrated in the cover
- large separating walls between the contacts guarantees high creeping and leakage distance
- mechanical position indication
- complete accessory
- all relays are 100% computer tested

applications

- switch panel making
- machine and plant industry
- switching between functions

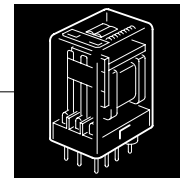

type number key

SFR 143 A 024VDC

coil voltages

024 VAC 024 VDC
 115 VAC 110 VDC
 230 VAC
 (other voltage ranges on enquiry)

option

A = mechanical position indication
 F = free wheel diode
 L = electrical position indication

relay version

SFR 142/082 PCB version
 SFR 143/083 plug-in version
 standard: manual actuation

order samples

manual actuation	position indication	free wheel diode	LED display								
•	•			SFR082 A	VDC/AC	SFR 142 A	VDC/AC	SFR 083 A	VDC/AC	SFR 143 A	VDC/AC
•	•	•		SFR082 AF	VDC	SFR 142 AF	VDC	SFR 083 AF	VDC	SFR 143 AF	VDC
•	•		•	SFR082 AL	VDC/AC	SFR 142 AL	VDC/AC	SFR 083 AL	VDC/AC	SFR 143 AL	VDC/AC
•	•	•	•	SFR082 AFL	VDC	SFR 142 AFL	VDC	SFR 083 AFL	VDC	SFR 143 AFL	VDC



SFR - Industry relay, 4-pole



number of contacts **4 WK**
 switching current range **50 mA to 5 A**
 inrush current **15 A**
 specialities **mechanical position indication**
mechanical actuation with lever

order numbers

SFR 143 A ..VDC/AC

contact specifications

contact material	AgCuNi
contact type	single contact
nominal switching capacity	250 VAC 5 A AC1 1250 VA 440 VAC 4 A AC1
electric life expectancy	app. 200'000 operations 250 VAC, 5 A, AC1 (360 operations/h)
max. inrush current	15 A for 20 ms
switching current range	50 mA to 5 A
switching power range	0,3 VA to 1760 VA

option

electrical position indication
 SFR 143 AL ..VDC/AC

general data

mechanic life expectancy	10 x 10 ⁶ operations
mechanical switching frequency	20 Hz
pull-in time	8 ms at DC / 3-9 ms at AC
release time	3,5 ms at DC / 4-12 ms at AC
bounce time normally open contact	3,0 ms at DC / 1-8 ms at AC
bounce time break contact	8 ms at DC / 9-16 ms at AC
shock resistance	AK: > 10 g
test voltage, coil/contact	2000 V _{eff}
test voltage, set of contacts/set of contacts	2000 V _{eff}
test voltage, open contact	1000 V _{eff}
insulation resistance	250 MΩ
creeping resistance	CTI 250
weight	app. 34 g
installation situation	any
ambient temperature	-40 to +70 °C
protection standard	IP 40

accessories

screw socket ES15/4N

tests, instructions

certificates	VDE
insulation group	VDE 0110 / group C 250 VAC

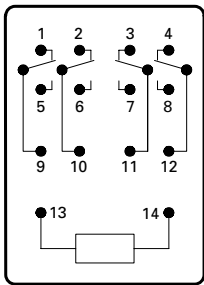
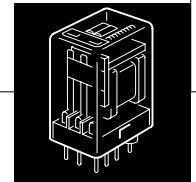

circuit diagram

dimensions

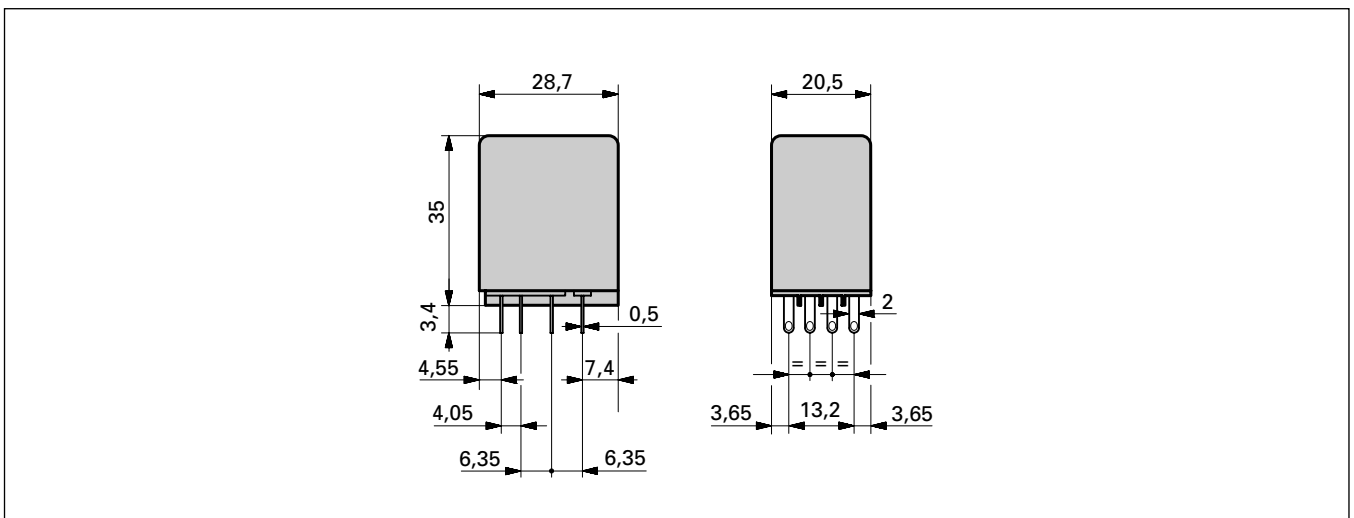

coil specifications

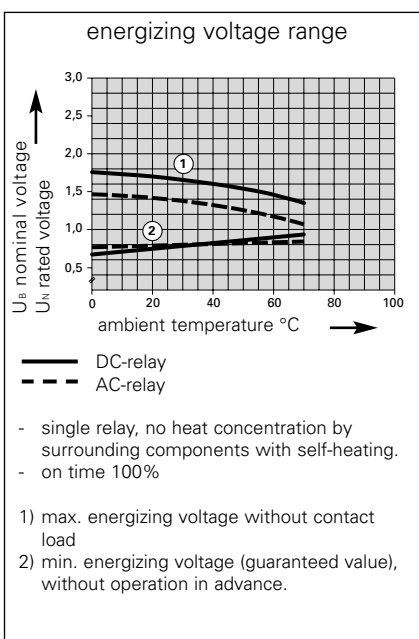

standard coils for direct current (other voltages on enquiry)

rated voltage VDC	pull-in voltage at 20 °C	reset voltage at 20 °C	nominal current mA	resistance Ohm at 20 °C	tolerance %
12	9,0	≥ 0,6	70,60	170	+/-10
24	18,0	≥ 1,2	37,21	645	+/-10
48	36,0	≥ 2,4	18,46	2'600	+/-10
110	82,5	≥ 5,5	8,33	13'200	+/-15

standard coils for alternated current (other voltages on enquiry)

VAC	pull-in voltage at 20 °C	reset voltage at 20 °C	nominal current mA	resistance Ohm at 20 °C	tolerance %
12	9,0	≥ 1,8	105,3	39	+/-10
24	18,0	≥ 3,6	51,6	165	+/-10
48	36,0	≥ 7,2	26,0	650	+/-10
110	82,5	≥ 16,5	12,9	3'500	+/-10
230	172,5	≥ 34,5	5,9	15'000	+/-15



SFR - industry relay, 2-pole



number of contacts **2 WK**
switching current range **50 mA to 5 A**
inrush current **15 A**
specialities **mechanical position indication**
mechanical actuation with lever

order numbers

SFR 083 A ..VDC/AC

contact specifications

contact material	AgCuNi
contact type	single contact
nominal switching capacity	250 VAC 5 A AC1 1250 VA 440 VAC 4 A AC1
electric life expectancy	app. 200'000 operations 250 VAC, 5 A, AC1 (360 operations/h)
max. inrush current	15 A for 20 ms
switching current range	50 mA to 5 A
switching power range	0,3 VA to 1760 VA

options

electrical position indication
SFR 083 AL ..VDC/AC

general data

mechanic life expectancy	10 x 10 ⁶ operations
mechanical switching frequency	20 Hz
pull-in time	8 ms at DC / 3-9 ms at AC
release time	3,5 ms at DC / 4-12 ms at AC
bounce time normally open contact	3,0 ms at DC / 1-8 ms at AC
bounce time break contact	8 ms at DC / 9-16 ms at AC
shock resistance	AK: > 10 g
test voltage, coil/contact	2000 V _{eff}
test voltage, set of contacts/set of contacts	2000 V _{eff}
test voltage, open contact	1000 V _{eff}
insulation resistance	250 MΩ
creeping resistance	CTI 250
weight	app. 34 g
installation situation	any
ambient temperature	-40 to +70 °C
protection standard	IP 40

accessories

screw socket ES15/2

tests, instructions

certificates	VDE
insulations group	VDE 0110 / group C 250 VAC

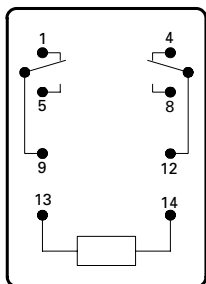
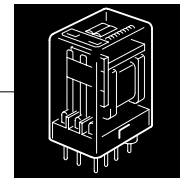

circuit diagram

dimensions

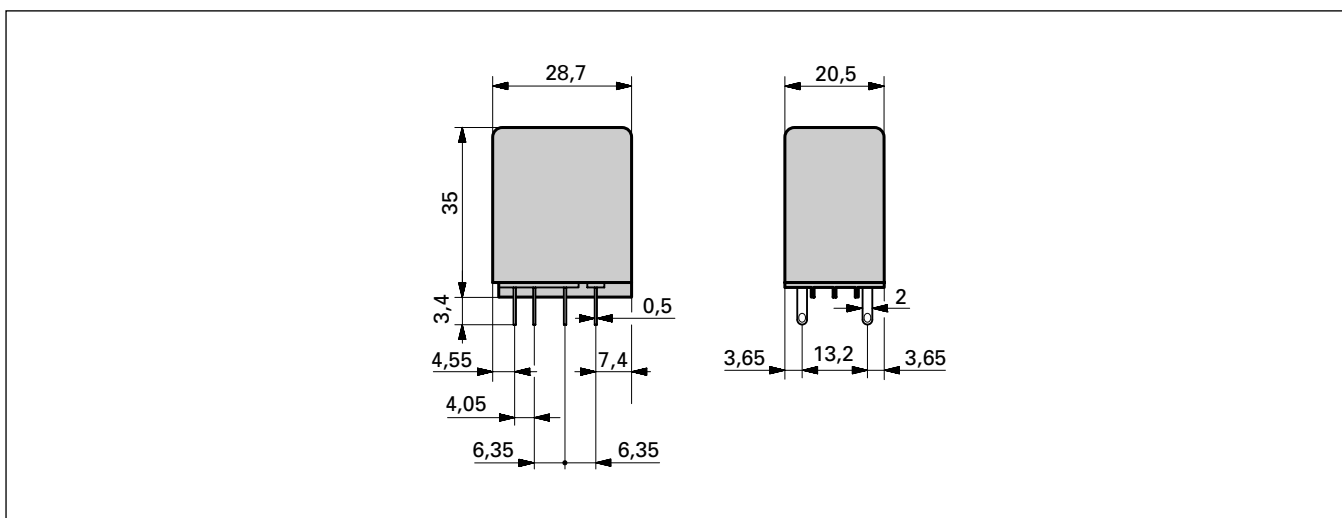

coil specifications

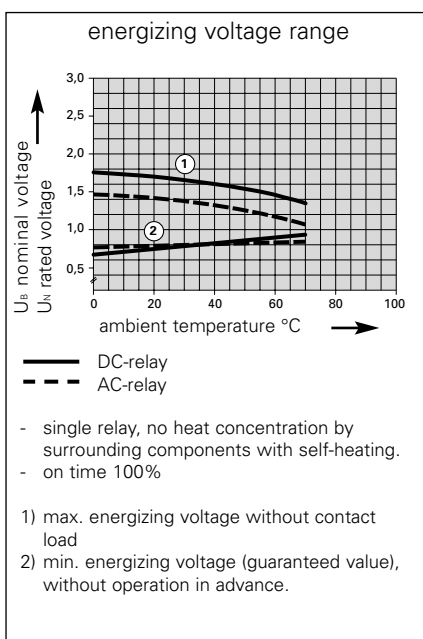

standard coils for direct current (other voltages on enquiry)

rated voltage VDC	pull-in voltage at 20 °C	reset voltage at 20 °C	nominal current mA	resistance Ohm at 20 °C	tolerance %
12	9,0	≥ 0,6	70,60	170	+/-10
24	18,0	≥ 1,2	37,21	645	+/-10
48	36,0	≥ 2,4	18,46	2'600	+/-10
110	82,5	≥ 5,5	8,33	13'200	+/-15

standard coils for alternated current (other voltages on enquiry)

VAC	pull-in voltage at 20 °C	reset voltage at 20 °C	nominal current mA	resistance Ohm at 20 °C	tolerance %
12	9,0	≥ 1,8	105,3	39	+/-10
24	18,0	≥ 3,6	51,6	165	+/-10
48	36,0	≥ 7,2	26,0	650	+/-10
110	82,5	≥ 16,5	12,9	3'500	+/-10
230	172,5	≥ 34,5	5,9	15'000	+/-15



SFR - industry relay, PCB version



number of contacts **4 WK**
switching current range **50 mA bis 5 A**
inrush current **15 A**
specialities **mechanical position indication**
mechanical actuation with lever

order numbers

SFR 142 A ..VDC/AC

contact specifications

contact material	AgCuNi
contact type	single contact
nominal switching capacity	250 VAC 5 A AC1 1250 VA 440 VAC 4 A AC1
electric life expectancy	app. 200'000 operations 250 VAC, 5 A, AC1 (360 operations/h)
max. inrush current	15 A for 20 ms
switching current range	50 mA to 5 A
switching power range	0,3 VA to 1760 VA

options

electrical position indication
SFR 142 AL ..VDC/AC

general data

mechanic life expectancy	10 x 10 ⁶ operations
mechanical switching frequency	20 Hz
pull-in time	8 ms at DC / 3-9 ms at AC
release time	3,5 ms at DC / 4-12 ms at AC
bounce time normally open contact	3,0 ms at DC / 1-8 ms at AC
bounce time break contact	8 ms at DC / 9-16 ms at AC
shock resistance	AK: > 10 g
test voltage, coil/contact	2000 V _{eff}
test voltage, set of contacts/set of contacts	2000 V _{eff}
test voltage, open contact	1000 V _{eff}
insulation resistance	250 MΩ
creeping resistance	CTI 250
weight	app. 34 g
installation situation	any
ambient temperature	-40 to +70 °C
protection standard	IP 40

tests, instructions

certificates	VDE
insulations group	VDE 0110 / group C 250 VAC

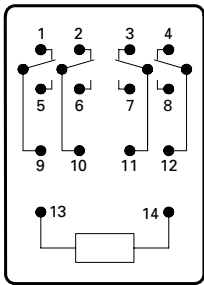
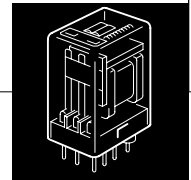

circuit diagram

dimensions

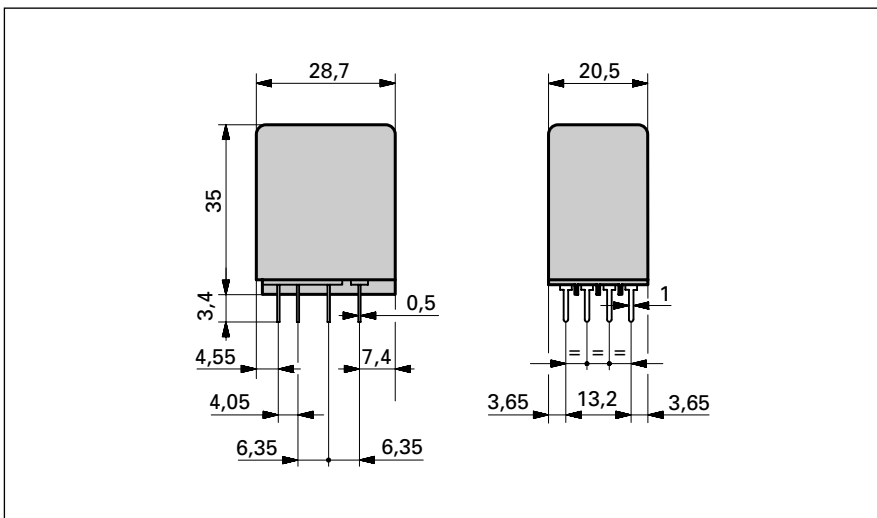

drilling plan

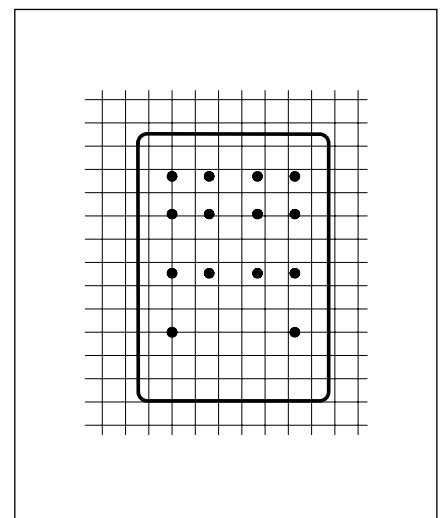

coil specifications

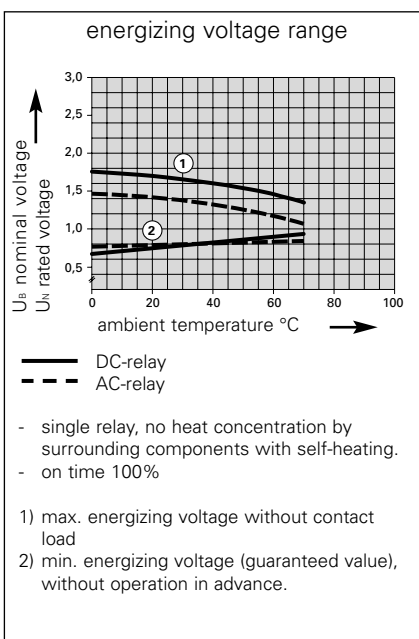

standard coils for direct current (other voltages on enquiry)

rated voltage VDC	pull-in voltage at 20 °C	reset voltage at 20 °C	nominal current mA	resistance Ohm at 20 °C	tolerance %
12	9,0	≥ 0,6	70,60	170	+/-10
24	18,0	≥ 1,2	37,21	645	+/-10
48	36,0	≥ 2,4	18,46	2'600	+/-10
110	82,5	≥ 5,5	8,33	13'200	+/-15

standard coils for alternated current (other voltages on enquiry)

VAC					
12	9,0	≥ 1,8	105,3	39	+/-10
24	18,0	≥ 3,6	51,6	165	+/-10
48	36,0	≥ 7,2	26,0	650	+/-10
110	82,5	≥ 16,5	12,9	3'500	+/-10
230	172,5	≥ 34,5	5,9	15'000	+/-15



SFR - industry relay, PCB version



number of contacts **2 WK**
switching current range **50 mA bis 5 A**
inrush current **15 A**
specialities **mechanical position indication**
mechanical actuation with lever

order numbers

SFR 082 A ..VDC/AC

contact specifications

contact material	AgCuNi
contact type	single contact
nominal switching capacity	250 VAC 5 A AC1 1250 VA 440 VAC 4 A AC1
electric life expectancy	app. 200'000 operations 250 VAC, 5 A, AC1 (360 operations/h)
max. inrush current	15 A for 20 ms
switching current range	50 mA to 5 A
switching power range	0,3 VA to 1760 VA

options

electrical position indication
SFR 082 AL ..VDC/AC

general data

mechanic life expectancy	10 x 10 ⁶ operations
mechanical switching frequency	20 Hz
pull-in time	8 ms at DC / 3-9 ms at AC
release time	3,5 ms at DC / 4-12 ms at AC
bounce time normally open contact	3,0 ms at DC / 1-8 ms at AC
bounce time break contact	8 ms at DC / 9-16 ms at AC
shock resistance	AK: > 10 g
test voltage, coil/contact	2000 V _{eff}
test voltage, set of contacts/set of contacts	2000 V _{eff}
test voltage, open contact	1000 V _{eff}
insulation resistance	250 MΩ
creeping resistance	CTI 250
weight	app. 34 g
installation situation	any
ambient temperature	-40 to +70 °C
protection standard	IP 40

tests, instructions

certificates	VDE
insulations group	VDE 0110 / group C 250 VAC

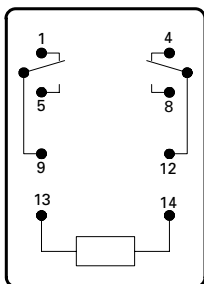
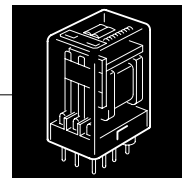

circuit diagram

dimensions

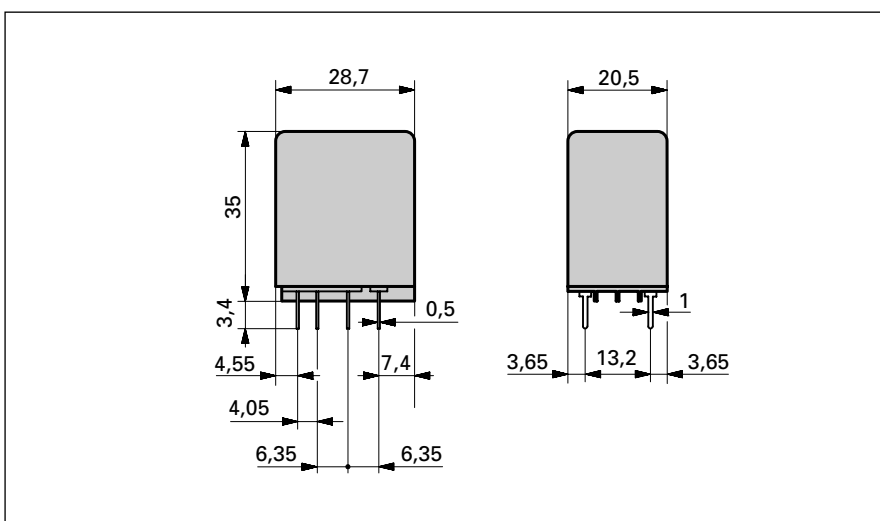

drilling plan

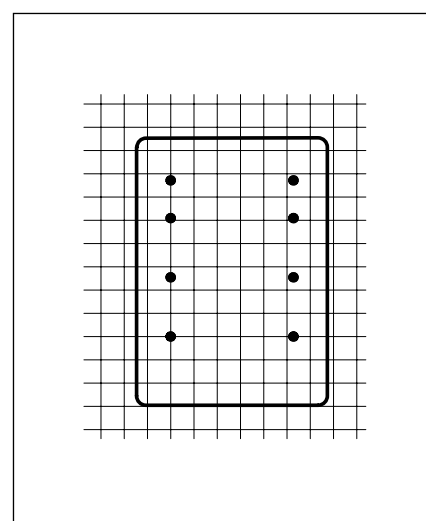

coil specifications

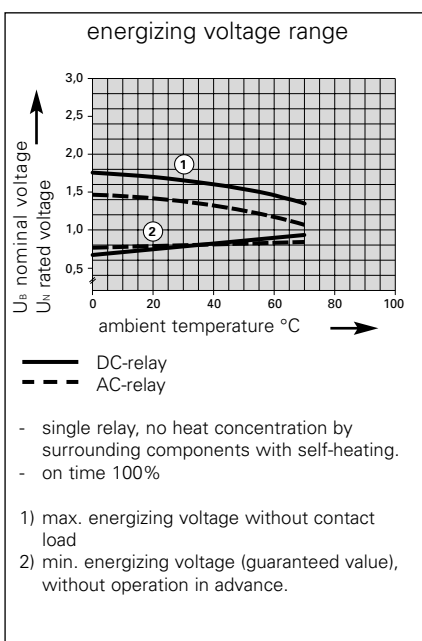

standard coils for direct current (other voltages on enquiry)

rated voltage VDC	pull-in voltage at 20 °C	reset voltage at 20 °C	nominal current mA	resistance Ohm at 20 °C	tolerance %
12	9,0	≥ 0,6	70,60	170	+/-10
24	18,0	≥ 1,2	37,21	645	+/-10
48	36,0	≥ 2,4	18,46	2'600	+/-10
110	82,5	≥ 5,5	8,33	13'200	+/-15

standard coils for alternated current (other voltages on enquiry)

VAC	pull-in voltage at 20 °C	reset voltage at 20 °C	nominal current mA	resistance Ohm at 20 °C	tolerance %
12	9,0	≥ 1,8	105,3	39	+/-10
24	18,0	≥ 3,6	51,6	165	+/-10
48	36,0	≥ 7,2	26,0	650	+/-10
110	82,5	≥ 16,5	12,9	3'500	+/-10
230	172,5	≥ 34,5	5,9	15'000	+/-15



SFR - contact specifications

AgCuNi single contact

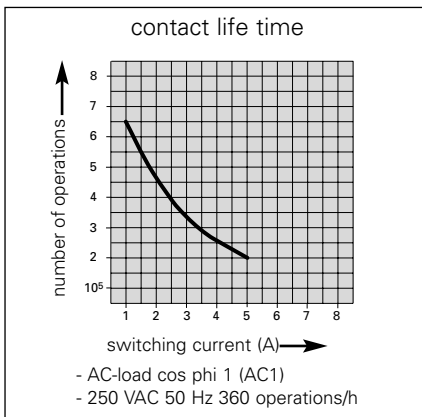
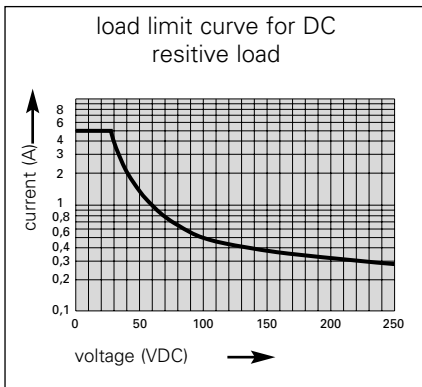

data valid for relay	SFR 143
contact material	AgCuNi (Ag1,88 Ni0,12)
contact type	single contact
nominal switching capacity	250 VAC 5 A AC1 1250 VA 440 VAC 4 A AC1
electric life expectancy	app. 200'000 operations 250 VAC 5 A AC1 (360 operations/h)
inrush current max.	15 A for 20 ms
switching current range	50 mA to 5 A
switching power range	0,3 VA to 2500 VA
contact resistance	20 mΩ

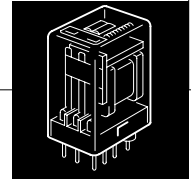

socket

ES15/4N



data

nominal data		300 VAC 12 A
dimensions (L x B x H)	[mm]	66 x 29,5 x 29
ambient temperature	[°C]	-40 to +85

accessories

plug-in modules	E...
metal clamp	Clip MHO
plastic clamp	Clip MS35

plug-in modules

E...

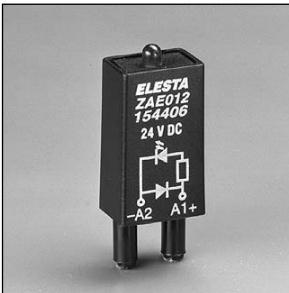

data

compatible to socket		ES15/4N
free wheel diode	230 VDC	E22
RC-circuit	240 VAC	E52C
LED	24 - 60 VAC/DC	E62EV
LED	110 - 230 VAC/DC	E92V



LR-power relay



the power relay LR

LR relays are power relays which convince by her brilliant simplicity. The mature and simple construction will predestine this relay for the rough and uncompromising use.

By using best materials and because of the simple construction a max. mechanical and electrical life time was achieved.

The special advantages of this mature relay lie in the high switching power as well as in the low power consumption of the coil.

The LR relay is available in AC- and also in DC- version

features

- simple construction
- high switching power
- low coil power
- extraordinary life time
- DIN rail mountable

applications

- switching of short-circuit runner engines
- radiators in household appliance
- radiators in electromechanical ovens

type number key

LR 024 VDC

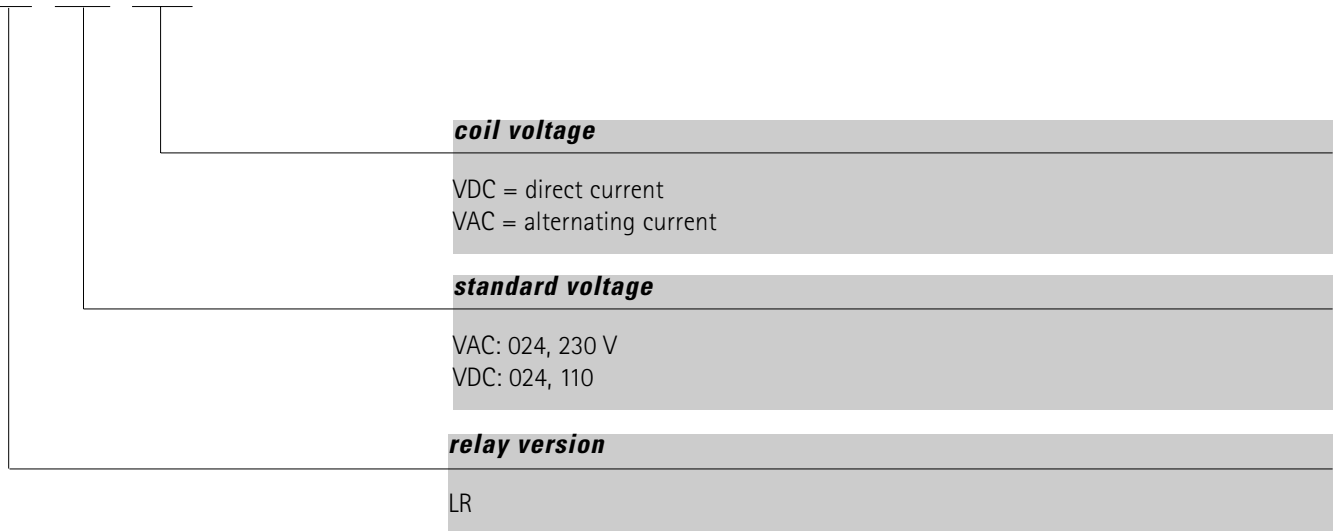

order sample

LR 230 VAC

- 3 normally open contacts
- coil voltage 230 VAC
- AMP connections
- DIN-rail installation



LR - power relay

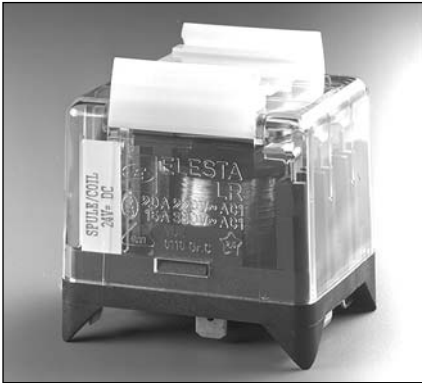

Power relays especially for switching high AC- loads.

order numbers

serial version	LR 220 VAC LR 24 VDC
----------------	-------------------------

contact specifications

(see data sheet for curves)

contact material	AgCdO
contact type	single contact
nominal switching capacity	250 VAC 20A AC1 5000 VA 400 VAC 15A AC1
electric life expectancy	app. 900'000 operations 250 VAC 20A AC1 (360 Schaltung/h)
inrush current max.	50A for 200 ms
switching current range	500mA to 20A
switching power range	8VA(W) to 5000VA

general data

max. switching frequency mechanical	15
mechanic life expectancy	20 Mio.
pull-in time	13 ms (VDC) /6-14 ms (VAC)
release time	2,5 ms (VDC) /3-12 ms (VAC)
bounce time	2 ms (VDC) /3 - 8 ms (VAC)
shock resistance	AK: 10 g
test voltage, coil/contact	2'500 V _{eff}
test voltage, open contact	2'500 V _{eff}
insulation resistance	>10 ¹² Ohm
weight	120 g
installation situation	any
ambient temperature max.	+60 °C

tests, instructions

certificates	CSA, VDE
insulation group	VDE 0110 / group C 250 VAC

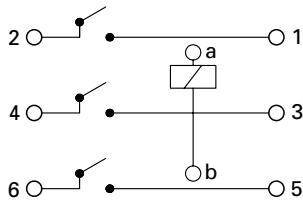
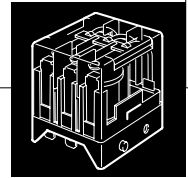

circuit diagram

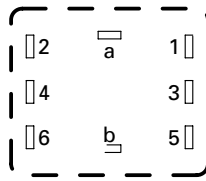

AMP connection side

dimensions

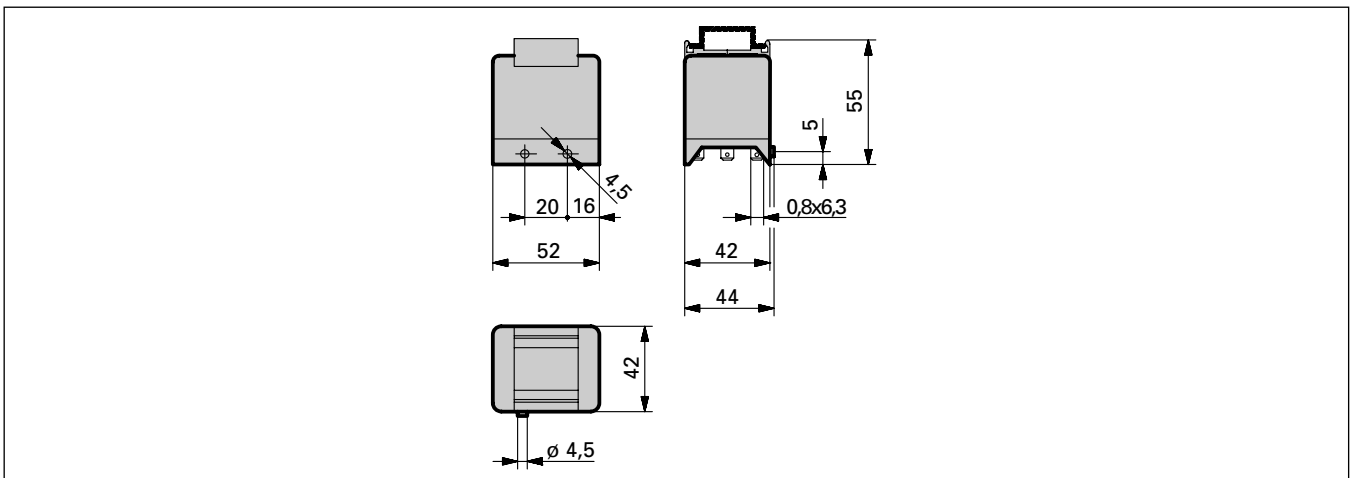

coil specifications

standard coils for direct current (other voltages on enquiry)

rated voltage VDC	pull-in voltage at 20 °C	reset voltage at 20 °C	nominal current mA	resistance Ohm at 20 °C	tolerance %
12	9	≥ 0,6	114	105	+/-10
24	18	≥ 1,2	58,5	410	+/-10
48	36	≥ 2,4	30,0	1'600	+/-10
110	82,5	≥ 5,5	13,8	8'000	+/-10

standard coils for alternated current (other voltages on enquiry)

VAC					
12	10,2	≥ 0,6	260	10	+/-10
24	20,4	≥ 1,2	130	40	+/-10
48	40,8	≥ 2,4	60	180	+/-10
110	93,5	≥ 5,5	29	950	+/-10
220	187	≥ 11	14	3'900	+/-10

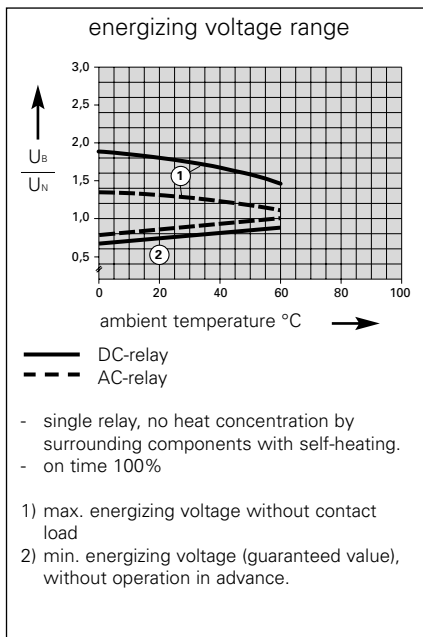

LR - contact specifications

AgCdO

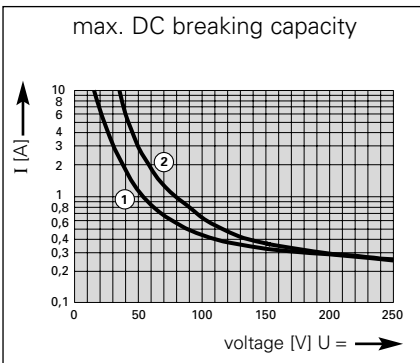

- 1 inductive load $L/R = 40$ ms
- 2 resistive load

data valid for relay

contact material

contact type

nominal switching capacity

electric life expectancy

inrush current max.

switching current range

switching power range

LR

AgCdO

single contact

250VAC 20A AC1 5000VA

400VAC 15A AC1

app. 900'000 operations

250 VAC 20A AC1 (360 Schaltung/h)

50A for 200 ms

500mA to 20A

8VA(W) to 5000VA(W)

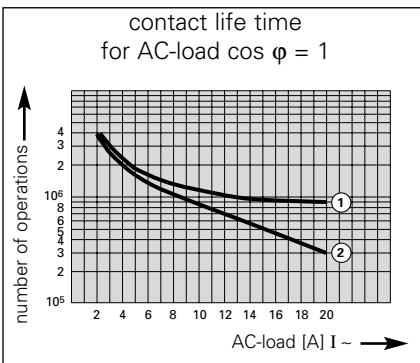

- 1: for 220 VAC (1-phase)
 - $I < 10$ A, max. 360 operations/h
 - $I > 10$ A, max. 180 operations/h
- 2: for 3 x 380 VAC (3-phase, star- or triangle circuit)
 - $I < 10$ A, max. 360 operations/h
 - $I > 10$ A, max. 180 operations/h

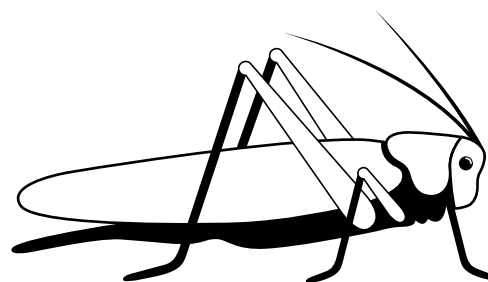
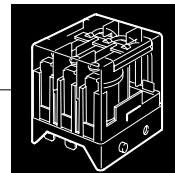

FR - miniature relay



the FR-miniature relay

FR relays are available with three or four change-over contacts. They are used as fail-safe elements in industrial electronics, automation and control.

features

- large product range
- simple, robust construction
- high switching power
- extraordinary life time
- high contact force
- flexible installation
- contact spring in Beryllium bronze

applications

- devices of automation and control

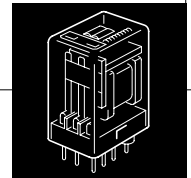

type number key

FR 11 P 024 VDC

	options
	switching current: 4A contact material: AgCuNi (4A) AgCuNi+Au4-6µm
	coil voltage
	VDC = direct current VAC = alternating current
	standard voltage
	VAC: 024, 110, 230 V VDC: 024, 110
	PCB version
	relay version
	FR 11 FR 14

order samples

FR 11 P 024 VDC 4A

- 3 change-over contacts
- PCB version
- coil voltage 24VDC
- nominal switching current 4 A

FR 14 P 230 VAC 4A

- 4 change-over contacts
- PCB version
- coil voltage 230VAC
- nominal switching current 4A



FR 11P - miniature relay

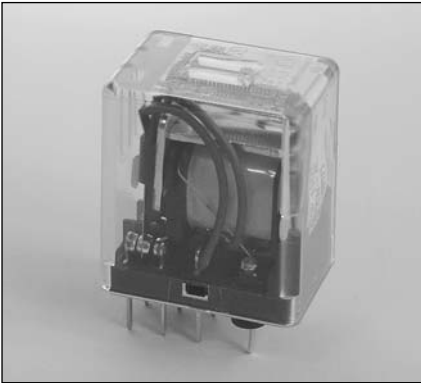

Miniaturised PCB-relay with three change-over contacts for industrial electronics.

order numbers

PCB version FR11P.VDC/VAC

contact specifications

(see data sheet for curves)

contact material	AgCuNi
contact type	single contact
nominal switching capacity	250 VAC 4 A AC1 500 VA
electric life expectancy	app. 150'000 operations 250 VAC 2A AC1 (360 Schaltung/h)
inrush current max.	15A for 200 ms
switching current range	50 mA to 2A
switching power range	0,3VA(W) to 500VA

options

contact material AgCuNi
 AgCuNi+Au10µm
(see data sheet for contacts)

general data

mechanic life expectancy	> 50 x 10 ⁶ operations
mechanical switching frequency	20 Hz
pull-in time	8 ms at DC / 3-9 ms at AC
release time	2,5 ms at DC / 4-12 ms at AC
bounce time normally open contact	3 ms at DC / 1-8 ms at AC
bounce time break contact	8 ms at DC / 3-16 ms at AC
shock resistance	AK: >10 g
test voltage, coil/contact	2'000 V _{eff}
test voltage, open contact	1'000 V _{eff}
insulation resistance	250 MΩ
weight	35 g
installation situation	any
ambient temperature	max. +60 °C

accessories

PCB socket ZB 87
metal clamp ZFR004

tests, instructions

certificates UL, CSA, VDE

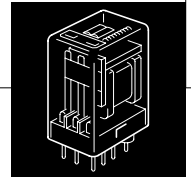

FR 11P

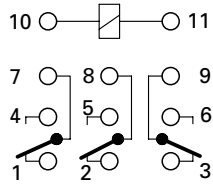

circuit diagram

FR 11P

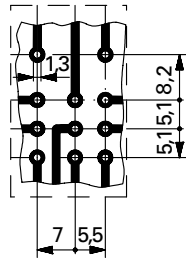

drilling plan (view on solder side)

dimensions

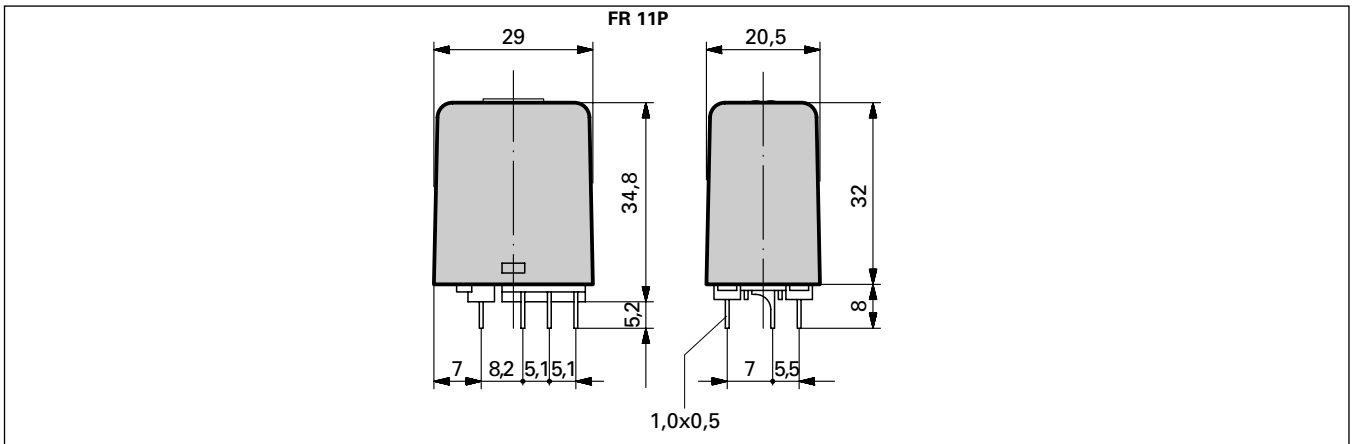

coil specifications

standard coils for direct current
(other voltages on enquiry)

rated voltage VDC	pull-in voltage at 20 °C	reset voltage at 20 °C	nominal current mA	resistance Ohm at 20 °C	tolerance %
12	10,2	≥ 0,6	82,7	145	+/-10
24	20,4	≥ 1,2	41,3	580	+/-10
36	30,6	≥ 1,8	26,6	1'350	+/-10
48	40,8	≥ 2,4	22,8	2'100	+/-10
110	93,5	≥ 5,5	11,5	9'500	+/-15

standard coils for alternated current
(other voltages on enquiry)

VAC	pull-in voltage at 20 °C	reset voltage at 20 °C	nominal current mA	resistance Ohm at 20 °C	tolerance %
12	10,2	≥ 0,6	105	39	+/-10
24	20,4	≥ 1,2	51,6	165	+/-10
36	30,6	≥ 1,8	32,7	373	+/-10
48	40,8	≥ 2,4	26,0	650	+/-10
110	93,5	≥ 5,5	12,9	3'500	+/-15
220	187	≥ 11,0	6,1	14'500	+/-15
230	195	≥ 11,5	5,8	15'000	+/-15



FR 14P - miniature relay



Miniaturised PCB-relay with three change-over contacts for industrial electronics.

order numbers

PCB version FR14P.VDC/VAC

contact specifications

(see data sheet for curves)

contact material	AgCuNi
contact type	single contact
nominal switching capacity	250 VAC 4 A AC1 1000 VA
electric life expectancy	app. 200'000 operations 250 VAC 4A AC1 (360 operations/h)
inrush current max.	15A for 200 ms
switching current range	50 mA to 4A
switching power range	0,3VA to 1000VA

options

contact material AgCuNi
 AgCuNi+Au10µm
(see data sheet for contacts)

general data

mechanic life expectancy	> 50 x 10 ⁶ operations
switching frequency mechanical	20 Hz
pull-in time	8 ms at DC / 3-9 ms at AC
release time	2,5 ms at DC / 4-12 ms at AC
bounce time normally open contact	3 ms at DC / 1-8 ms at AC
bounce time break contact	8 ms at DC / 3-16 ms at AC
shock resistance	AK: >10 g
test voltage, coil/contact	2'000 V _{eff}
test voltage, open contact	1'000 V _{eff}
insulation resistance	250 MΩ
weight	38 g
installation situation	any
ambient temperature	max. +60 °C

accessories

PCB socket ZB 107
metal clamp ZFR004

tests, instructions

certificates UL, CSA, VDE

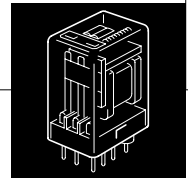

FR 14P

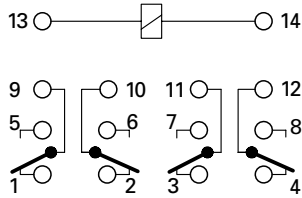

circuit diagram

FR 14P

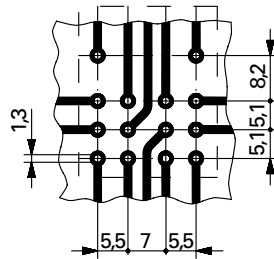

drilling plan (view on solder side)

dimensions

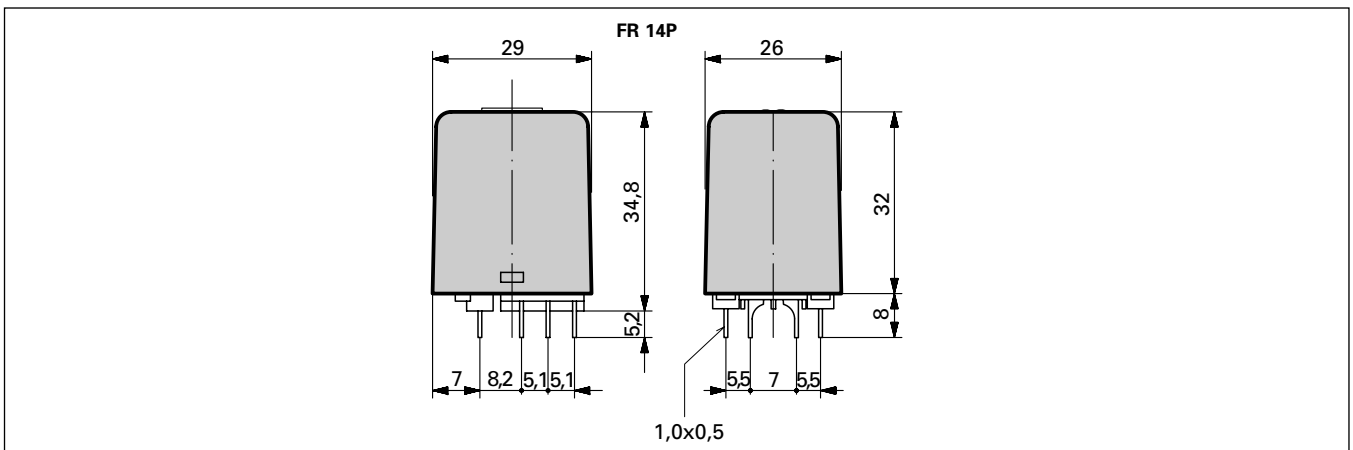

coil specifications

standard coils for direct current
(other voltages on enquiry)

rated voltage VDC	pull-in voltage at 20 °C	reset voltage at 20 °C	nominal current mA	resistance Ohm at 20 °C	tolerance %
12	10,2	≥ 0,6	109	110	+/-10
24	20,4	≥ 1,2	52,1	460	+/-10
36	30,6	≥ 1,8	36,0	1'000	+/-10
48	40,8	≥ 2,4	28,2	1'700	+/-10
110	93,5	≥ 5,5	11,5	9'500	+/-15

standard coils for alternated current
(other voltages on enquiry)

VAC	pull-in voltage at 20 °C	reset voltage at 20 °C	nominal current mA	resistance Ohm at 20 °C	tolerance %
12	10,2	≥ 0,6	148	30	+/-10
24	20,4	≥ 1,2	68,5	130	+/-10
36	30,6	≥ 1,8	46,7	300	+/-10
48	40,8	≥ 2,4	35,5	540	+/-10
110	93,5	≥ 5,5	16,4	2'900	+/-15
220	187	≥ 11,0	6,1	14'500	+/-15
230	195	≥ 11,5	5,8	15'000	+/-15



FR - contact specifications

AgCuNi 4A

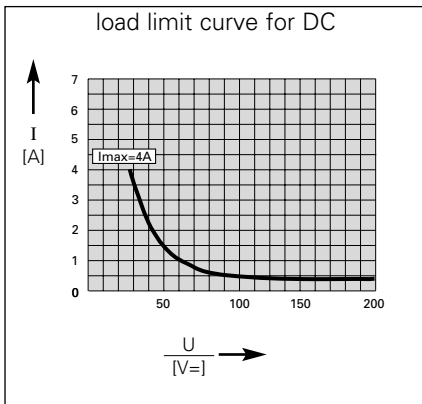

- resistive load

data valid for relay	FR 11 FR 14
contact material	AgCuNi (AgCu 1,88 Ni0,12)
contact type	single contact
nominal switching capacity	250VAC 4A AC1 1000VA
electric life expectancy	app. 200'000 operations 250 VAC 4A AC1 (360 operations/h)
inrush current max.	15A for 200 ms
switching current range	50mA to 4A
switching power range	0,3VA to 1000VA

AgCuNi+Au 10µm

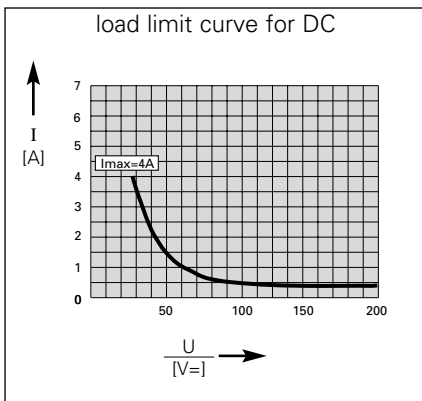

- resistive load

data valid for relay	FR 11 FR 14
contact material	AgCuNi+Au 10µm
contact type	single contact
nominal switching capacity	250VAC 2A AC1 500VA
electric life expectancy	app. 100'000 operations 250 VAC 2A AC1 (360 operations/h)
inrush current max.	6A for 200 ms
switching current range	10mA to 2A
switching power range	0,06VA to 500VA

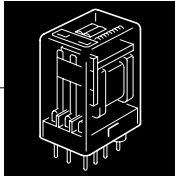

PR - PCB relay

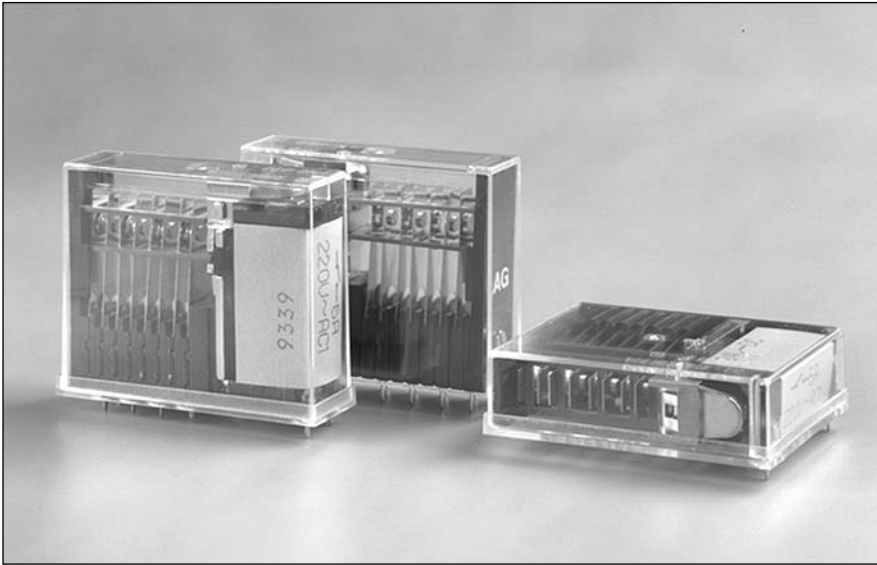

the PR-PCB relay

PCB-Relay from the PR family are small relays. The version has forced guided contacts, 2 normally open contacts, 2 normally closed contacts.

In the industrial electronic as well as in the control industry they are used as fail-save elements.

The forced guided contact version are often used in control systems of high safe applications.

By using best materials and because of the simple construction the highest fail-security was achieved.

High precision in mechanical and electrical control guarantees the high and stable quality of the relays.

features

- simple fail-save construction
- high switching power
- high load current
- extraordinary life time
- high contact force
- security distance according to VDE and CSA
- minimal dimensions
- the forced guided contact version, SUVA approved.

applications

- devices of automation and control

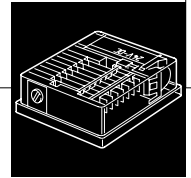

type number key

PR 4 ... 024 VDC

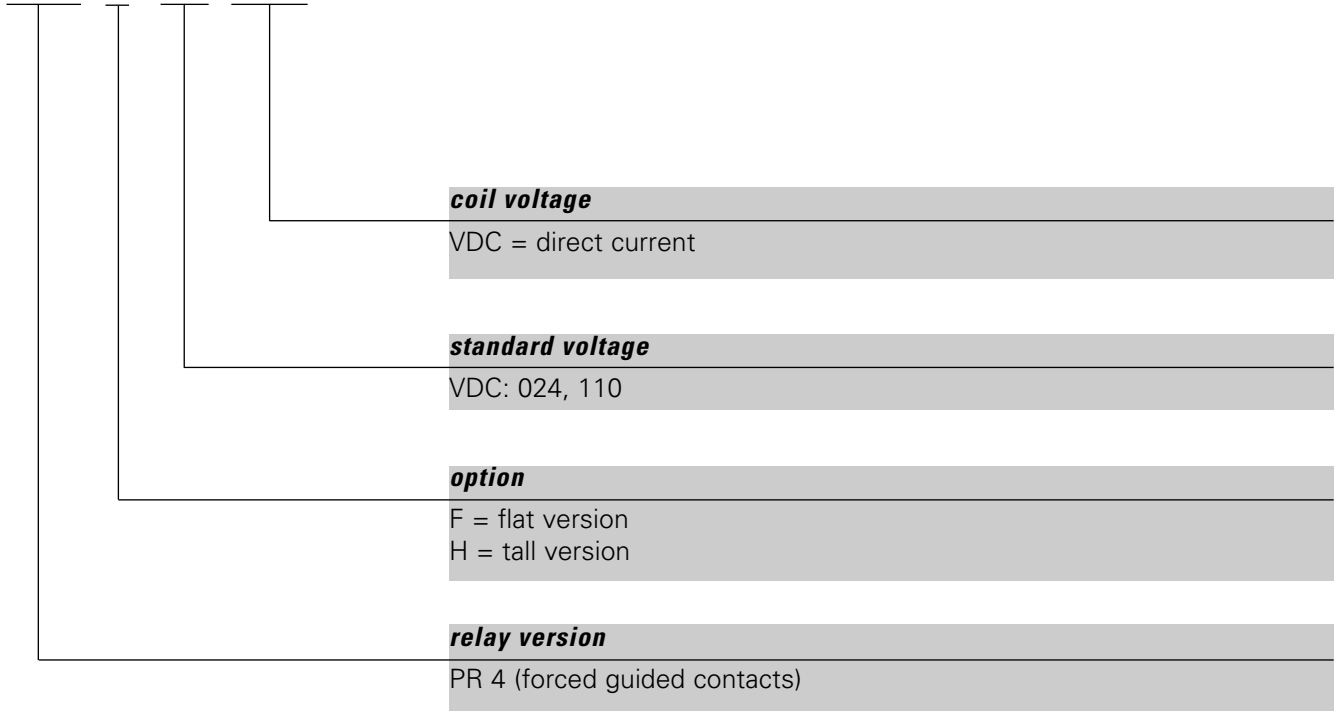

order sample

PR 4 F 024 VDC

- PCB-relay with forced guided contacts
- flat version
- coil voltage 24 VDC



PR 4F - PCB relay

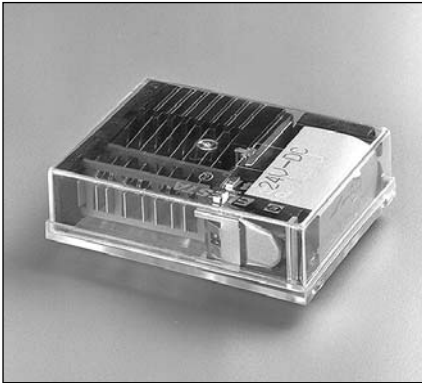

PCB-relay with forced guided contacts, flat version with 2 normally open contacts, and 2 normally closed contacts

order numbers

serial version PR 4F .. VDC

contact specifications

(see data sheet for curves)

contact material	AgCuNi
contact type	single contact
nominal switching capacity	250 VAC 6 A AC1 1500 VA
electric life expectancy	app. 100'000 operations 250 VAC 6A AC1 (360 Schaltung/h)
inrush current	15 A for 200 ms
switching current range	50 mA to 6A
switching power range	0,3VA to 1500VA

general data

mechanic life expectancy	> 20 x 10 ⁶ operations
mechanical switching frequency	20 Hz
pull-in time	10 ms
release time	2,5 ms
bounce time normally open contact	6 ms
bounce time break contact	6 ms
test voltage, coil/contact	2'000 V _{eff} / 50 Hz
test voltage, open contact	1'500 V _{eff}
insulation resistance	2x10 ¹¹ Ohm
weight	30 g
installation situation	any
ambient temperature	max. +60 °C

tests, instructions

certificates CSA, VDE, SUVA

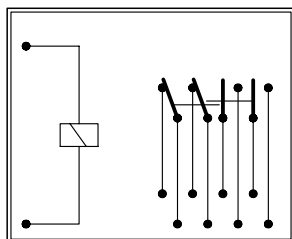
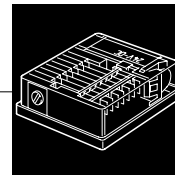

circuit diagram (view from the top)

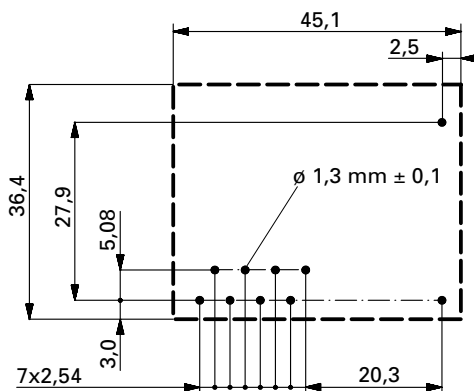

drilling plan (view on solder side)

dimensions

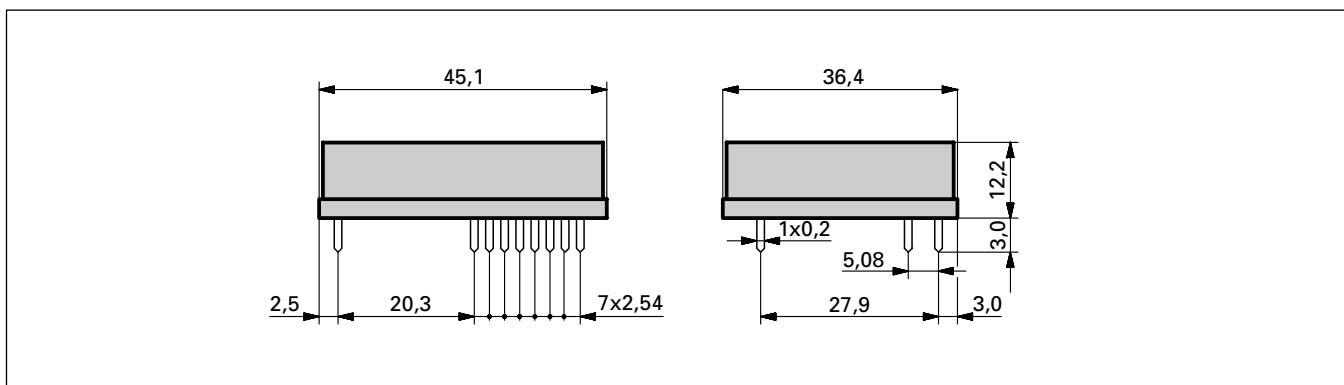

coil specifications

standard coils for direct current (other voltages on enquiry)

rated voltage VDC	pull-in voltage at 20 °C	reset voltage at 20 °C	nominal current mA	resistance Ohm at 20 °C	tolerance %
6	5,1	≥ 0,3	222	27	+/-10
12	10,2	≥ 0,6	109	110	+/-10
24	20,4	≥ 1,2	54,5	440	+/-10
48	40,8	≥ 2,4	30	1'600	+/-10
110	93,5	≥ 5,5	10,3	10'600	+/-13



PR 4H - PCB relay

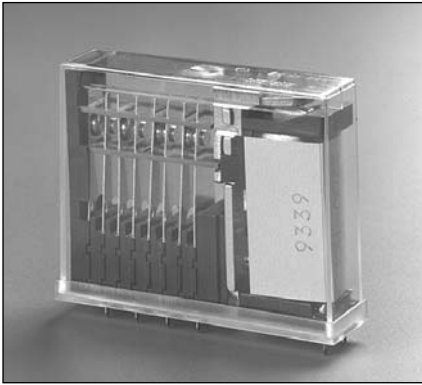

PCB-relay with forced guided contacts, tall version with 2 normally open contacts, and 2 normally closed contacts

order numbers

serial version PR4H .. VDC

contact specifications

(see data sheet for curves)

contact material	AgCuNi
contact type	single contact
nominal switching capacity	250 VAC 6 A AC1 1500 VA
electric life expectancy	app. 100'000 operations 250 VAC 6A AC1 (360 operations/h)
inrush current max.	15 A for 200 ms
switching current range	50 mA to 6A
switching power range	0,3VA to 1500VA

general data

mechanic life expectancy	> 20 x 10 ⁶ operations
mechanical switching frequency	20 Hz
pull-in time	10 ms
release time	2,5 ms
bounce time normally open contact	6 ms
bounce time break contact	6 ms
test voltage, coil/contact	2'000 V _{eff} / 50 Hz
test voltage, open contact	1'500 V _{eff}
insulation resistance	2x10 ¹¹ Ohm
weight	30 g
installation situation	any
ambient temperature	max. +60 °C

tests, instructions

certificates CSA, VDE, SUVA

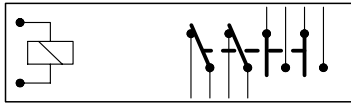
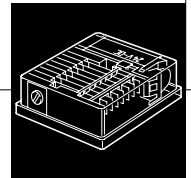

circuit diagram (view from the top)

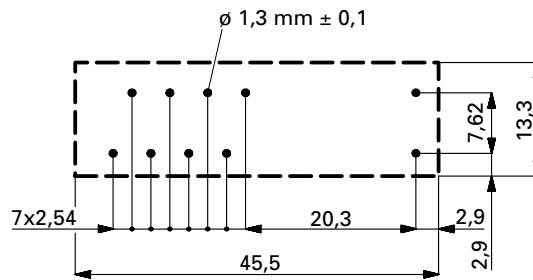

drilling plan (view on solder side)

dimensions

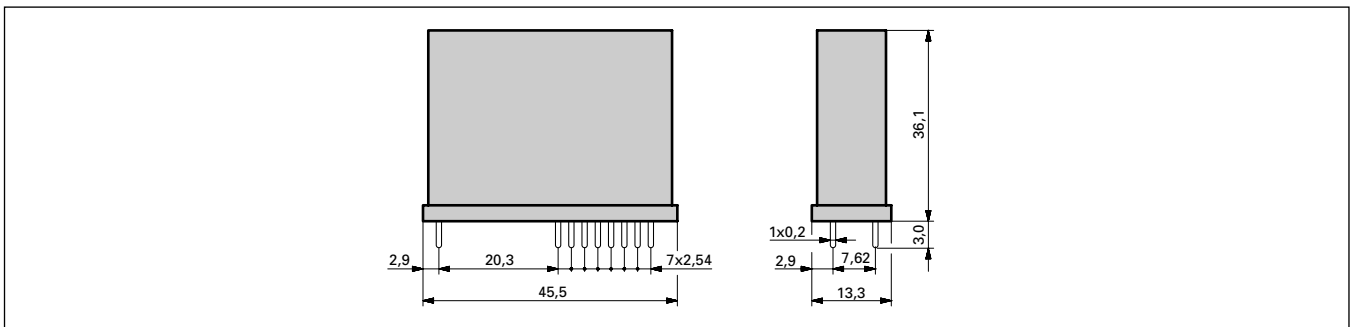

coil specifications

standard coils for direct current (other voltages on enquiry)

rated voltage VDC	min. pull-in voltage at 20 °C	release voltage at 20 °C	nominal current mA	resistance Ohm at 20 °C	tolerance %
6	5,1	≥ 0,3	222	27	+/-10
12	10,2	≥ 0,6	109	110	+/-10
24	20,4	≥ 1,2	54,5	440	+/-10
48	40,8	≥ 2,4	30	1'600	+/-10
110	93,5	≥ 5,5	10,3	10'600	+/-13

contact specifications (AgCuNi 6A single contact)

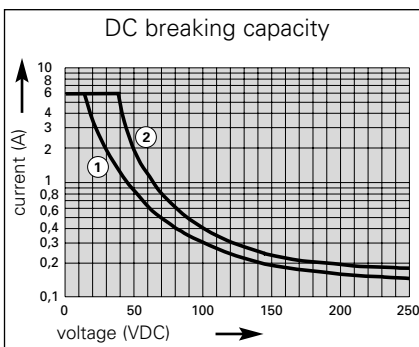

data valid for relay

contact material
contact type
nominal switching capacity
electric life expectancy

inrush current max.
switching current range*
switching power range*
contact resistance
*typical values

PR 4F PR 4H
AgCuNi (AgCu1,8Ni0,12)
single contact
250VAC 6A AC1 1500VA
app. 100'000 operations 250 VAC 6A AC1 (360 operations/h)
15A for 200 ms
50mA to 6A
0,3VA(W) to 1500VA(W)
≤ 120mΩ in the new condition

- 1) inductive load, L/R 40 ms
2) resistive load



MR - special relay

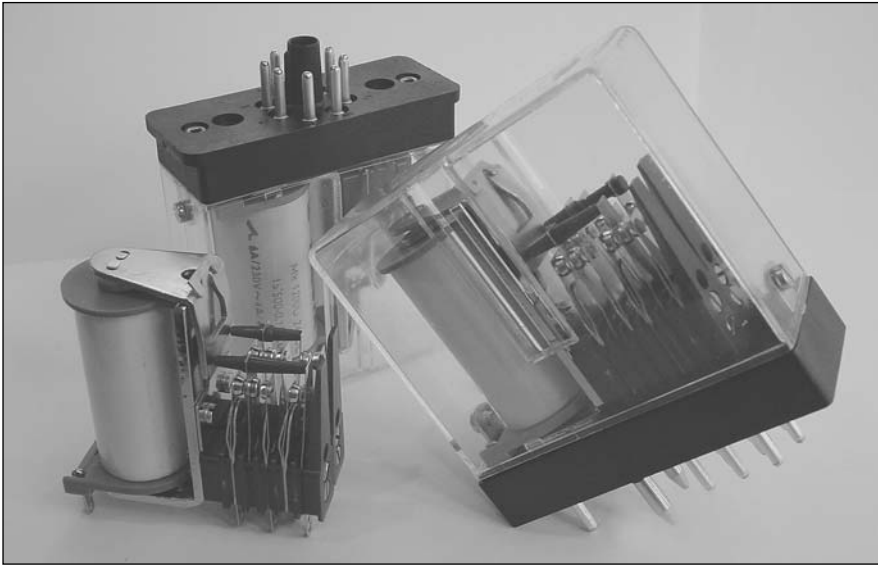

the special relay MR

MR relays are fail-safe and universal useable elements with excellent contact load and high pull-in sensitivity.

The big bobbin and the variability of the contacts make a lot of versions for different applications possible.

features

- different versions enable the ideal adaption for different applications.
- short contact springs enable bounce-free switching.
- special synthetic-layers and a substantial over-travel are the reasons for the constancy and safety at a large number of operations, also in bad climate conditions.

applications

- industrial electronics
- automation and control



Special relays with different contact versions for several applications.

order numbers

soldering version MRL
... VDC/ VAC
plug-in version
8-pole MR8 ...VDC/ VAC
plug-in version
14-pole MR ...VDC/ VAC

contact specifications

(see data sheet for curves)

contact material	AgCuNi
contact type	single contact
nominal switching capacity	250 VAC 6 A AC1 1500 VA
electric life expectancy	dependence of the version
inrush current max.	15 A for 20 ms
switching current range	50 mA to 6A

options

contact material AgCuNi
contact versions up to 6 pairs optionally

general data

mechanic life expectancy	> 50 x 10 ⁶ operations
mechanical switching frequency	10 Hz
pull-in time	10-30 ms
release time	6-8 ms
test voltage, coil/contact	2'000 V _{eff}
test voltage, open contact	2'000 V _{eff}
weight	dependence of the version
installation situation	dependence of the version
ambient temperature	max. +60 °C

accessories

socket 8-pole ZKR 088
socket 14-pole ZB 35
metal clamp MR8 ZFR 002
metal clamp MR14 ZFR 003

coil specifications

standard coils for direct current:	3 - 300 VDC
standard coils for alternated current:	3 - 240 VAC



notes



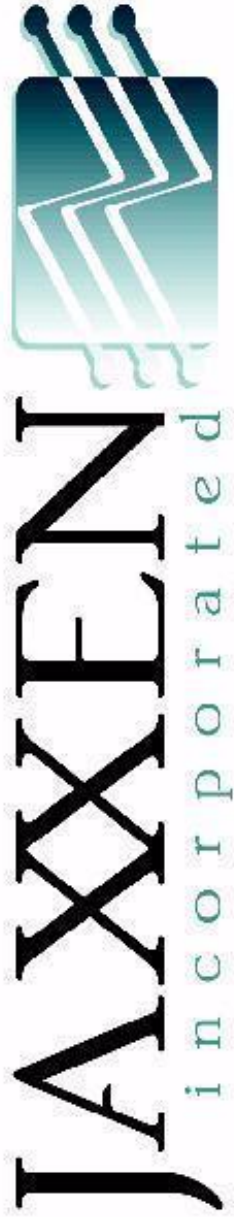

www.jaxxeninc.com

203-838-6200 • info@jaxxeninc.com

ELESTA
optosensors



Electrical Switches



Electrical Connectors



WANJIA RELAY



Recognize
and react accordingly



RF Components

Product Catalog 2005

ELESTA

Elesta Elektrotechnik AG

CH-7310 Bad Ragaz

Telefon ++41(0)81. 300 42 00

info@elesta.ch

Elestastrasse 16

Telefax ++41(0)81. 300 42 01

www.elesta.ch

catalog 2002 e / 04.03



350 Milford Point Rd. Milford, CT 06460 P.203-878-0400 F.203-878-0458
www.jaxxeninc.com info@jaxxeninc.com