

# Rotary Switch

## RCP 203 SERIES



### 適用於：

1. 多迴路、多接點的切換選擇
2. 各類儀器設備
3. 軍民用通訊器材

### 特性：

1. 防潮、防塵功能
2. 鍍金處理，可耐久置
3. 體積小，耐電流大(1A)

### APPLICABLE TO :

1. Switching selection with multi-position and multi-pole.
2. For general instrument and equipment use.
3. For military and civilian tele-communication equipment use.

### CHARACTERISTIC :

1. With dust prevent and moisture prevent functions.
2. Gold-plating terminal and contactor for long time use.
3. Small size with direct current 1A.

## 特性規格 SPECIFICATION

### 項目 ITEM

定 格 RATING	DC 30V 1A
接觸電阻 CONTACT RESISTANCE	20mΩ MAX
絕緣電阻 INSULATION RESISTANCE	DC 500V 100MΩ MIN
耐 電 壓 WITHSTAND VOLTAGE	500V 1 MINUTE
動 作 力 TORQUE	2±1 kg/cm
接觸狀態 TIMING	SHORTING OR NON SHORTING
壽命測試 LIFE TEST	10,000 CYCLES NO LOAD
手焊耐熱溫度 RESISTANCE TO MANUAL SOLDERING HEAT	260±10°C 3 sec

## 多層式組合開關之層數，迴路數，段數及本體長之互動說明 ILLUSTRATION OF MULTI-SECTION SWITCHES POLE, POSITION AND BODY LENGTH (mm)

層數(1~12) SECTION	迴路數 POLE	段數(2~12) POSITIONS	L (本體長) BODY LENGTH
1	6	2	6 mm
	4	3	
	3	4	
	2	5~6	
	1	7~12	
2	12	2	12 mm
	8	3	
	6	4	
	4	5~6	
3	2	7~12	18 mm
	18	2	
	12	3	
	9	4	
	6	5~6	
4	3	7~12	24 mm
	24	2	
	16	3	
	12	4	
	8	5~6	

**RCP 203 前段組立爆炸圖，具防水設計功能**  
The explode drawing of construct of shaft with front cover for RCP203, it has water proof design.

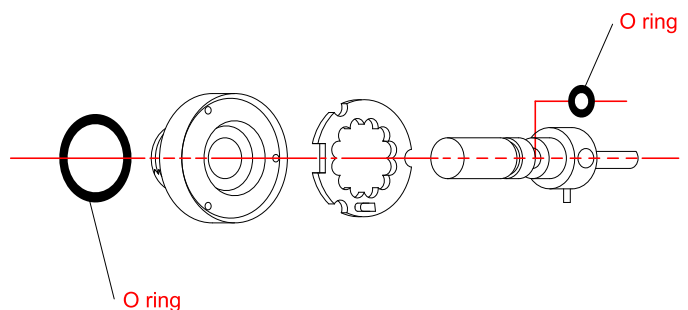

# Rotary Switch

## RCP 203 SERIES

### 2 Position Series

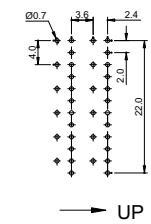
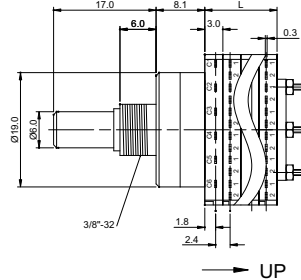
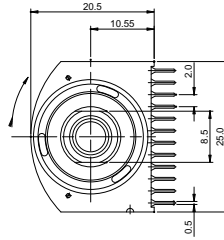

P.C.B. HOLE

UP

### 3 Position Series

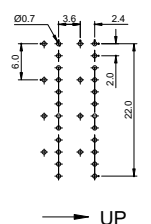
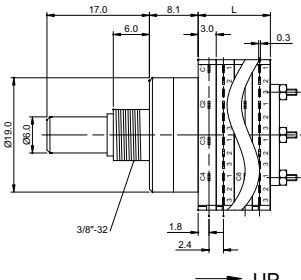
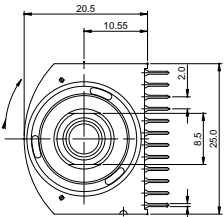

P.C.B. HOLE

UP

### 4 Position Series

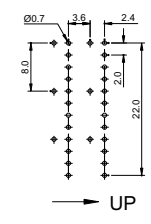
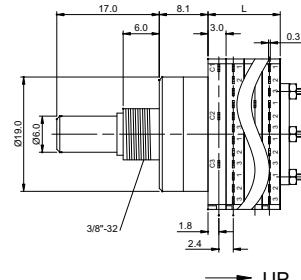
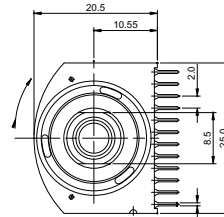

P.C.B. HOLE

UP

### 5~6 Position Series

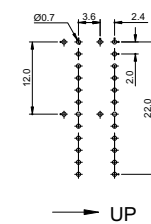
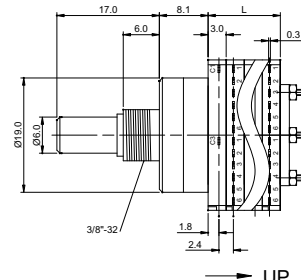
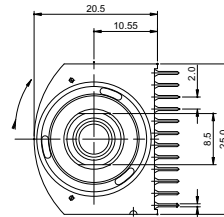

P.C.B. HOLE

UP

### 7~12 Position Series

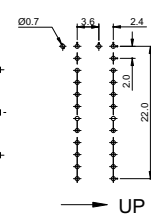
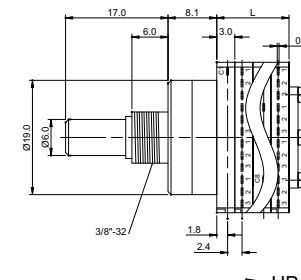
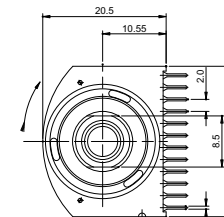

P.C.B. HOLE

UP