

OT SERIES

RELAY SOCKETS

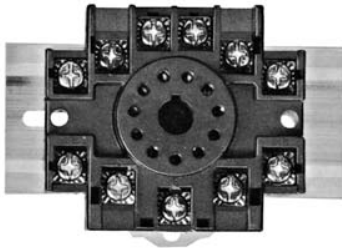
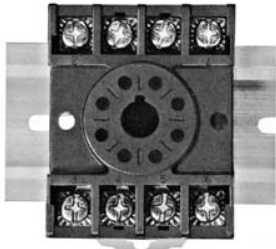

CUSTOM CONNECTOR

DESCRIPTION

8 and 11 Pin Octal Sockets, DIN Rail Mountable

ELECTRICAL RATING

- OT08, OT08-PC - 600 Volts, 10 Amps
- ****NEW UPGRADED RATING - OT08-PC*****
- OT11, OT11-PC - 300 Volts, 10 Amps

CONSTRUCTION

- Contacts** • Brass, Nickel Plated
- Screws** • Binder Head, 6 - 32 x 1/4" Steel, Zinc Plated
- Pressure Clamp, 6 - 32 x 5/16" Steel, Zinc Plated, Wire Range #12 - #22 Solid or Stranded
- Molding** • Break Resistant Thermoplastic Black Standard, Grey Available

AGENCY APPROVALS

- UL recognized, File No. E60008
- CSA certified, File No. LR29513
- CE



ORDERING CODE

PART NO.	DESCRIPTION	TERMINAL TYPE
OT08	DPDT, 8 Pin Octal (Fig. 1)	Binder Head Screws
OT08-PC	DPDT, 8 Pin Octal (Fig. 1)	Pressure Clamp Screws
OT11	3PDT, 11 Pin Octal Style (Fig. 2)	Binder Head Screws
OT11-PC	3PDT, 11 Pin Octal Style (Fig. 2)	Pressure Clamp Screws

ACCESSORIES

PART NO.	DESCRIPTION (Refer to the accessories pages 25-27)
C-103-PM	Prepunched Aluminum DIN Rail (1 Meter Lengths)
C-104-PM	Prepunched Steel DIN Rail (1 Meter Lengths)
C-105-PM	Prepunched Steel DIN Rail (1 Meter Lengths)
C-106-2PM	Prepunched Steel DIN Rail (2 Meter Lengths)
C-108-PM	Prepunched Raised Aluminum DIN Rail (1 Meter Lengths)
C-108-2PM	Prepunched Raised Aluminum DIN Rail (2 Meter Lengths)

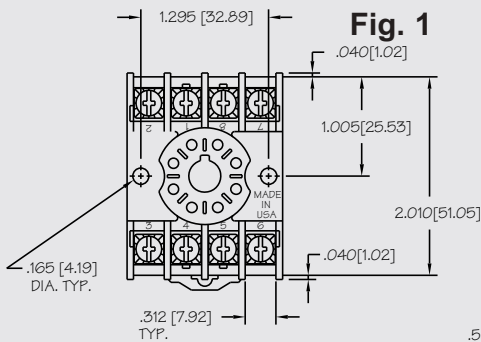

NOTE: OT08 SAME AS OT08-PC BUT WITH BINDER HEAD SCREWS

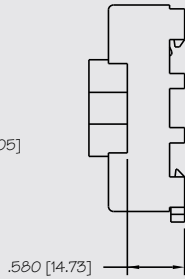

TERMINAL LOCATION

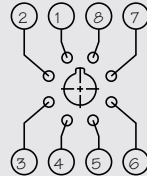

TOP VIEW

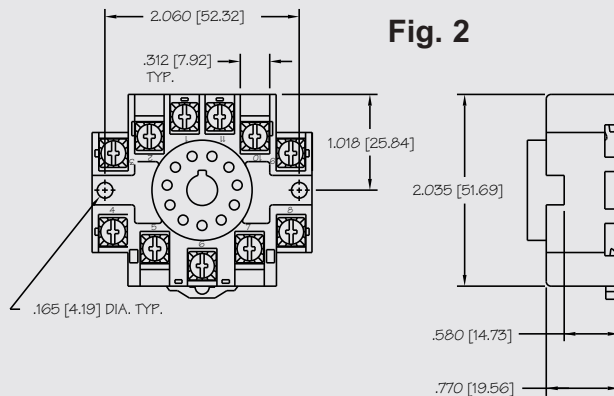
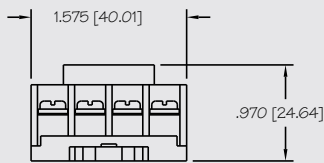

TERMINAL LOCATION

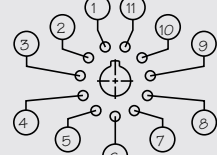

TOP VIEW

